

**Scotts Garden Tractor
GT2554**

OMM139955 C2

OPERATOR'S MANUAL



***Manufactured
by John Deere***



JOHN DEERE

North American Version
Litho in U.S.A.

INTRODUCTION

Thank You for Purchasing a Scotts Product

We appreciate having you as a customer and wish you many years of safe and satisfied use of your machine.

Using Your Operator's Manual

This manual is an important part of your machine and should remain with the machine when you sell it.

Reading your operator's manual will help you and others avoid personal injury or damage to the machine. Information given in this manual will provide the operator with the safest and most effective use of the machine. Knowing how to operate this machine safely and correctly will allow you to train others who may operate this machine.

If you have an attachment, use the safety and operating information in the attachment operator's manual along with the machine operator's manual to operate the attachment safely and correctly.

This manual and safety signs on your machine may also be available in other languages (see your John Deere dealer to order).

Sections in your operator's manual are placed in a specific order to help you understand all the safety messages and learn the controls so you can operate this machine safely. You can also use this manual to answer any specific operating or servicing questions. A convenient index located at the end of this book will help you to find needed information quickly.

The machine shown in this manual may differ slightly from your machine, but will be similar enough to help you understand our instructions.

RIGHT-HAND and LEFT-HAND sides are determined by facing in the direction the machine will travel when going forward. When you see a broken line arrow (----->), the item referred to is hidden from view.

Before delivering this machine, your dealer performed a predelivery inspection to ensure best performance.

Special Messages

Your manual contains special messages to bring attention to potential safety concerns, machine damage as well as helpful operating and servicing information. Please read all the information carefully to avoid injury and machine damage.



CAUTION: Avoid injury! This symbol and text highlight potential hazards or death to the operator or bystanders that may occur if the hazards or procedures are ignored.

IMPORTANT: Avoid damage! This text is used to tell the operator of actions or conditions that might result in damage to the machine.

NOTE: General information is given throughout the manual that may help the operator in the operation or service of the machine.

CALIFORNIA Proposition 65 Warning



Warning: The Engine Exhaust from this product contains chemicals known to the State of California to cause cancer, birth defects or other reproductive harm.

PRODUCT IDENTIFICATION

Record Identification Numbers

Scotts Garden Tractor

GT2554 Serial No. (GX2554S010001 -)

When contacting an Authorized Service Center for information, always provide product model and serial number.

Locate identification number for machine and for engine. Record information in spaces provided below.



MX13481

DATE OF PURCHASE:

DEALER NAME:

DEALER PHONE:

PRODUCT IDENTIFICATION NUMBER (A):

ENGINE SERIAL NUMBER (B):

Register Your Product and Warranty Online

To register your product through the Internet, simply go to www.JohnDeereWarrantyRegistration.com. Completing the information, either online or with the product warranty card, will ensure the customer that their product receives all post sales service and important product information.

TABLE OF CONTENTS

Safety	1
Assembly	8
Operating.....	10
Replacement Parts	21
Service Interval Chart.....	22
Service Lubrication	23
Service Engine	24
Service Transmission.....	29
Service Mower.....	30
Service Electrical.....	34
Service Miscellaneous.....	37
Troubleshooting	38
Storing Machine.....	42
Specifications	44
Warranty	46
Index.....	49

All information, illustrations and specifications in this manual are based on the latest information at the time of publication. The right is reserved to make changes at any time without notice.

COPYRIGHT© 2002

Deere & Co.

John Deere Worldwide Commercial and Consumer Equipment Division

All rights reserved

Previous Editions

COPYRIGHT© 2001, 2000, 1999, 1998, 1997

OMM139955 C2 - English

SAFETY

Understanding Machine Safety Labels



Safety-Alert Symbol

The machine safety labels shown in this section are placed in important areas on your machine to draw attention to potential safety hazards.

On your machine safety labels, the words DANGER, WARNING, and CAUTION are used with this safety-alert symbol. DANGER identifies the most serious hazards.

The operator's manual also explains any potential safety hazards whenever necessary in special safety messages that are identified with the word, CAUTION, and the safety-alert symbol.

DANGER

Rotating Blade



MX13481

- Do not put hands or feet under or into mower when engine is running.

THROWN OBJECTS

- Before mowing, clear area of objects that may be thrown by blade.
- Do not operate mower without discharge chute or entire

grass catcher in place.

DANGER

ROTATING BLADES CUT OFF ARMS AND LEGS



M47707/MX13481

- Do not mow when children or others are around
- Do not mow in reverse
- Look down and behind before and while backing
- Never carry children even with blades off

WARNING: AVOID SERIOUS INJURY OR DEATH

- Drive up and down slopes, not across
- Avoid sudden turns
- If machine stops going uphill, stop blade and back down slowly
- Keep safety devices (guards, shields, and switches) in place and working
- Read operator's manual
- When leaving machine:
 - Stop engine
 - Set park brake
 - Remove key

SAFETY

WARNING: LOADED SPRING



M47589/M88552/MX13481

Lock lift lever forward before changing attachments.

DANGER

ROTATING BLADE



MX13481

Picture Note: Located on left side of mower

Do not put hands or feet under or into mower when engine is running.

DANGER/POISON



MX13481

Picture Note: Located on battery

- Shield eyes. Explosive gases can cause blindness or injury.
- No sparks, flames, smoking
- Sulfuric acid can cause blindness or severe burns
- Flush eyes immediately with water. Get medical help fast.
- Maintenance-free.
- Keep out of the reach of children. Do not tip. Do not open battery!

CAUTION



M138932/MX13481

To avoid injury from spring loaded tension arm, read operator's manual before releasing.

SAFETY

Emission Control System Certification Label

NOTE: Tampering with emission controls and components by unauthorized personnel may result in severe fines or penalties. Emission controls and components can only be adjusted by EPA and/or CARB authorized service centers. Contact John Deere Commercial and Consumer Equipment Retailer concerning emission controls and component questions.

The presence of an emissions label signifies that the engine has been certified with the United States Environmental Protection Agency (EPA) and/or California Air Resources Board (CARB).

The emissions warranty applies only to those engines marketed by John Deere that have been certified by the EPA and/or CARB; and used in the United States and Canada in off-road mobile equipment.

Emission Compliance Period

If engine has emission compliance category listed on the emission control system certification or air index label, this indicates the number of operating hours for which the engine has been certified to meet EPA and/or CARB emission requirements. The following table provides the engine compliance period in hours associated with the category found on the certification label.

Agency	Category	Hours
EPA	C	250
EPA	B	500
EPA	A	1000
CARB	Moderate	125
CARB	Intermediate	250
CARB	Extended	500

Certification

Your mower has been certified by an independent laboratory for compliance with American National Standard B-71.1, "Safety Specifications" for Power Lawn Mowers, Lawn and Garden Tractors, and Lawn Tractors.

Operating Safely

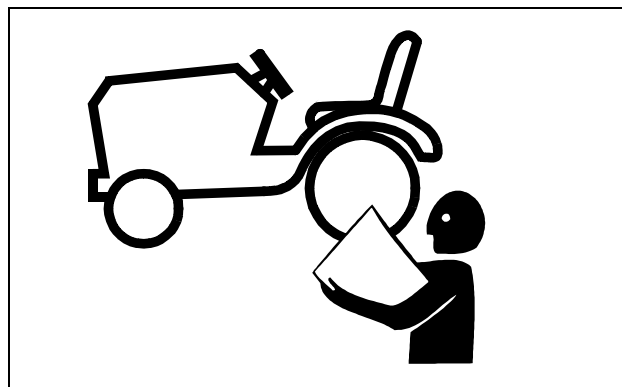

- Read, understand and follow all instructions in the manual, on the machine and on the safety video before starting.
- Only allow responsible adults, who are familiar with the instructions to operate the machine.
- Be thoroughly familiar with the controls and the proper use of the machine before starting.
- Inspect machine before you operate. Be sure hardware is tight. Repair or replace damaged, badly worn, or missing parts. Be sure guards and shields are in good condition and fastened in place. Make any necessary adjustments before you operate.
- Do not operate mower without discharge chute or entire grass catcher in place.
- Check brake action before you operate. Adjust or service brakes as necessary.
- Stop machine if anyone enters the area.
- If you hit an object, stop the machine and inspect it. Make repairs before you operate. Keep machine and attachments properly maintained and in good working order.
- Be aware of the mower discharge direction and make sure that no one is in the path of the discharge direction.
- Do not leave machine unattended when it is running.
- Only operate during daylight or with good artificial light.
- Be careful of traffic when operating near or crossing roadways.
- Older adults are involved in a large percentage of riding mower accidents involving injury. These operators should evaluate their ability to operate a mower safely enough to protect the operator and others from serious injury.

SAFETY

Rotating Blades are Dangerous

HELP PREVENT SERIOUS OR FATAL ACCIDENTS:

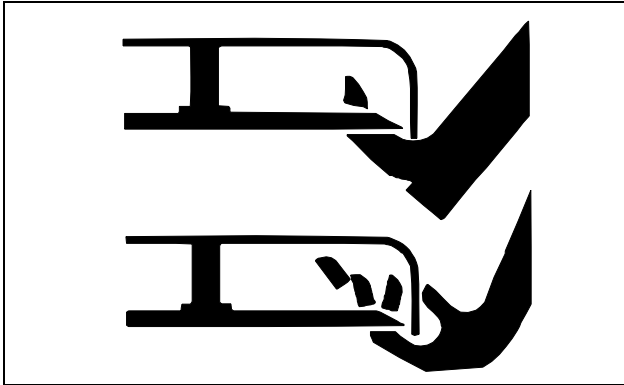

- Rotating blades can cut off arms and legs, and throw objects. Failure to observe safety instructions could result in serious injury or death.
- Keep hands, feet and clothing away from mower deck when engine is running.
- Be alert at all times, drive forward carefully. People, especially children can move quickly into the mowing area before you know it.
- Before backing up, stop mower blades or attachments and look down and behind the machine carefully, especially for children.
- Do not mow in reverse.
- Shut off blades when you are not mowing.
- Do not operate machine if you are under the influence of drugs or alcohol.
- Park machine safely before inspecting, removing, or unplugging mower or bagger.

PROTECT CHILDREN:

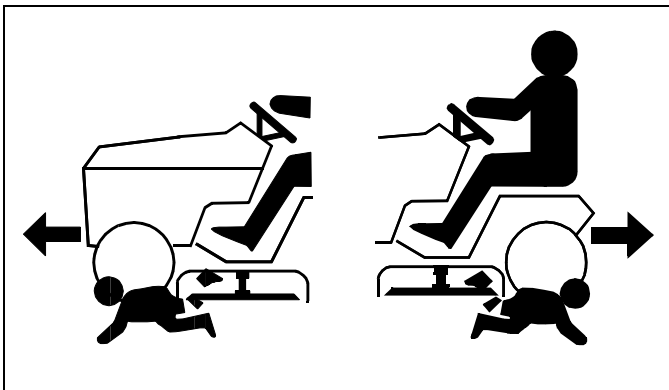

- Tragic accidents can occur if the operator is not alert to the presence of children. Keep children out of the mowing area and under the watchful care of another responsible

adult.

- Never assume that children will remain where you last saw them. Children are attracted to mowing activity, stay alert to the presence of children.
- Keep children indoors when you are mowing. Turn the machine off if a child enters the mowing area.
- Use extra care when you come to blind corners, shrubs, trees, or other objects that may block your vision.
- Do not let children or an untrained person operate the machine.
- Do not carry or let children ride on any attachment or machine even with the blades off. Do not tow children in a cart or trailer.

Parking Safely

- Stop machine on a level surface, not on a slope.
- Disengage mower blades.
- Lower attachments to the ground.
- Lock park brake.
- Stop engine.
- Remove key.
- Before leaving operator's seat, wait for engine and all moving parts to stop.

Avoid Tipping

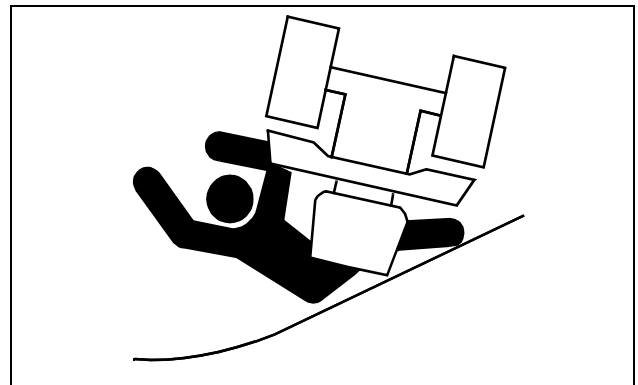

- Slopes are a major factor related to loss-of-control and tip-over accidents, which can result in severe injury or death. All slopes require extra caution. If you cannot back up the slope or if you feel uneasy on it, do not mow it.
- Keep all movement on slopes slow and gradual. Do not make sudden changes in speed or direction.
- Slow down before you make a sharp turn or operate on

SAFETY

a slope. Choose a low gear or speed so that you will not have to stop or shift while on the slope.

- Do not turn on slopes unless necessary. Turn slowly and turn downhill. Do not shift to neutral and coast downhill.
- Stay alert for holes and other hidden hazards in the terrain. Uneven terrain could overturn the machine. Tall grass can hide obstacles.
- Keep away from drop-offs, ditches and embankments.
- Use extra care with grass catchers or other attachments. These can change the stability of the machine. Do not use grass catcher on steep slopes.
- Use recommended weights for added stability when operating on slopes or using front or rear mounted attachments. Remove weights when not required.
- Drive up and down a hill - not across.
- Do not stop when going up hill or down hill. If machine stops going up hill, disengage mower blades and back down slowly.
- Mowing when grass is wet can cause reduced traction and sliding.
- Do not try to stabilize the machine by putting your foot on the ground.

Keep Riders Off



- Only allow the operator on the machine. Keep riders off.
- Riders on the machine or attachment may be struck by foreign objects or thrown off the machine causing serious injury.
- Riders obstruct the operator's view resulting in the machine being operated in an unsafe manner.

Driving Safely on Public Roads

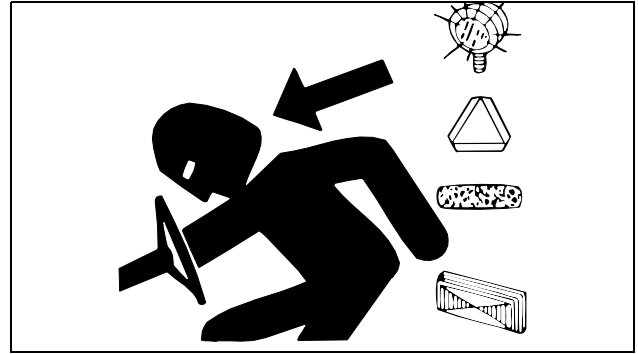

Avoid personal injury or death resulting from a collision with another vehicle on public roads:

- Use safety lights and devices. Slow moving machines when driven on public roads are hard to see, especially at night.
- Whenever driving on public roads, use flashing warning lights and turn signals according to local regulations. Extra flashing warning lights may need to be installed.

Checking Mowing Area

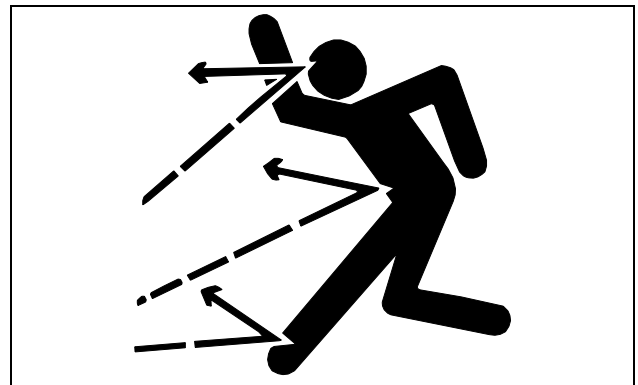

- Clear mowing area of objects that might be thrown. Keep people and pets out of mowing area.
- Study mowing area. Set up a safe mowing pattern. Do not mow where traction or stability is doubtful.
- Test drive area with mower lowered but not running. Slow down when you travel over rough ground.

Towing Loads Safely

- Limit loads to those you can safely control. Use only approved hitches when pulling loads or using heavy equipment. Use counterweights or wheel weights as required in this manual or your attachment manual.

SAFETY

- Do not tow children in a cart or trailer.
- Travel slowly and allow extra distance to stop.
- Follow the manufacturer's recommendation for weight limits for towed equipment and towing on slopes.
- Tow only with a machine that has a hitch designed for towing. Do not attach towed equipment except at the hitch point.
- On slopes, the weight of towed equipment may cause loss of traction and loss of control.

Wear Appropriate Clothing



- Always wear safety goggles or safety glasses with side shields when operating the mower.
- Wear close fitting clothing and safety equipment appropriate for the job.
- Wear a suitable protective device such as earplugs. Loud noise can cause impairment or loss of hearing.
- Do not wear radio or music headphones. Safe service and operation requires your full attention.

Prevent Fires

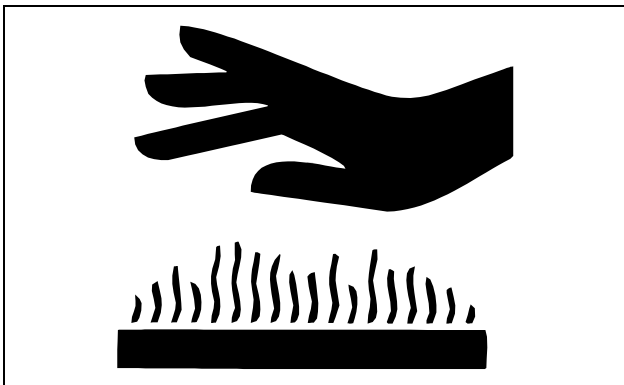

- Remove grass and debris from engine compartment and muffler area, before and after operating machine, especially after mowing or mulching in dry conditions.
- To reduce fire hazard, keep engine and engine compartment free of grass, leaves, or excessive grease.
- Allow engine to cool before storing in any enclosure.
- Never remove fuel cap, or add fuel with engine running or hot. Allow engine to cool for several minutes.
- Never store equipment with fuel in the tank inside a building where fumes may reach an open flame or spark.

Tire Safety



Explosive separation of a tire and rim parts can cause serious injury or death:

- Do not attempt to mount a tire without the proper equipment and experience to perform the job.
- Always maintain the correct tire pressure. Do not inflate the tires above the recommended pressure. Never weld or heat a wheel and tire assembly. The heat can cause an increase in air pressure resulting in a tire explosion. Welding can structurally weaken or deform the wheel.
- When inflating tires, use a clip-on chuck and extension hose long enough to allow you to stand to one side and NOT in front of or over the tire assembly.
- Check tires for low pressure, cuts, bubbles, damaged rims or missing lug bolts and nuts.

SAFETY

Handling Fuel Safely

Fuel and fuel vapors are highly flammable:



- Do not refuel machine while you smoke, when machine is near an open flame or sparks, or when engine is running. stop engine and allow to cool before filling.
- Never remove the fuel cap or add fuel with the engine running.
- Never fill fuel tank or drain fuel from a machine in an enclosed area. Fill fuel tank outdoors.
- Prevent fires. Clean up spilled fuel immediately.
- Do not store machine with fuel in tank in a building where fumes may reach an open flame or spark.
- Prevent fire and explosion caused by static electric discharge. Use only non-metal, portable fuel containers approved by the Underwriter's Laboratory (U.L.) or the American Society for Testing & Materials (ASTM). If using a funnel, make sure it is plastic and has no screen or filter.

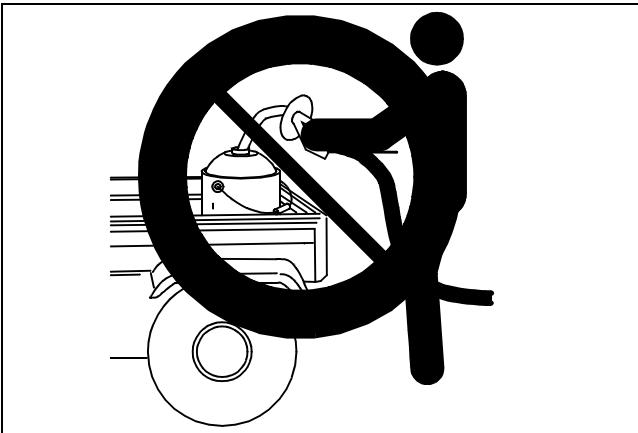

- Static electric discharge can ignite gasoline vapors in an ungrounded fuel container. Remove the fuel container from the bed of a vehicle or the trunk of a car and place on the ground away from the vehicle before filling. Keep nozzle in contact with container opening while filling.
- When practical, remove equipment from trailers or truck

beds and refuel them on the ground. If this is not possible, use a portable, plastic fuel container to refuel equipment on a truck bed or trailer.

- For gasoline engines, do not use gas with methanol. Methanol is harmful to your health and to the environment.

Handling Waste Product and Chemicals

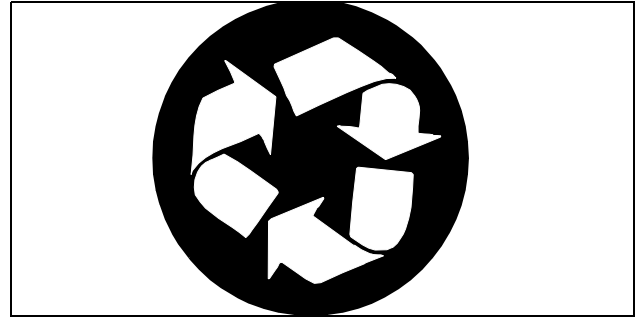

Waste products, such as, used oil, fuel, coolant, brake fluid, and batteries, can harm the environment and people:

- Do not use beverage containers for waste fluids - someone may drink from them.
- See your local Recycling Center or John Deere dealer to learn how to recycle or get rid of waste products.
- A Material Safety Data Sheet (MSDS) provides specific details on chemical products: physical and health hazards, safety procedures, and emergency response techniques. The seller of the chemical products used with your machine is responsible for providing the MSDS for that product.

ASSEMBLY

Identify Parts

Clear Plastic Bag Contains:

- Operator's Manual
- Safety Video
- Warranty Cards

Bag of Parts Contains:

- Hardware for Steering Wheel
- Hardware for Battery Cables
- Key Chain
- Padded Key

NOTE: *There is an extra ignition key strapped to one of seat suspension springs.*

Install Steering Wheel

1. Put front wheels in straight forward position.
2. Lubricate steering shaft.
3. Install steering wheel with logo in upright position.

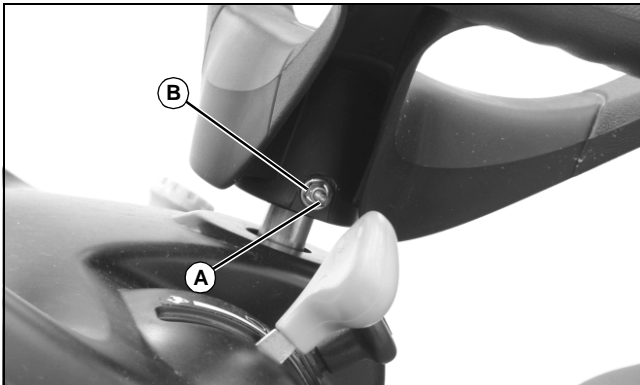

MX13512

4. Install shoulder bolt (A). Drive bolt in until head of bolt contacts steering wheel.
5. Install washer and nut (B).
6. Tighten lock nut until it is snug. Do not tighten lock nut to pull washer or head of bolt into steering wheel.

Install and Connect Battery

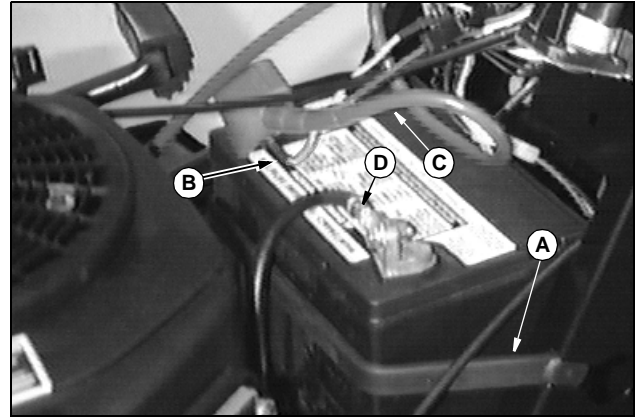

M88565

1. Install battery and secure with hold-down strap (A)
2. Remove and discard red positive (+) protective cap from positive (+) battery terminal.
3. Connect blue harness wire (B) and red positive (+) cable (C) to battery. Apply petroleum jelly or silicone spray to terminal to prevent corrosion. Make sure connection is tight. Install red terminal cover.
4. Remove and discard black (-) protective cap from negative battery terminal.
5. Connect black negative (-) cable (D) to battery. Apply petroleum jelly or silicone spray to terminal to prevent corrosion. Make sure connection is tight.

Check Engine Oil

IMPORTANT: Avoid damage! Do not run engine if oil level is below add mark.

1. Lift hood.



MX13511

2. Remove dipstick (A). Wipe with clean cloth.
3. Insert dipstick into tube and rest oil fill cap on tube. Do not thread cap onto tube.

ASSEMBLY

4. Remove dipstick to check oil level.

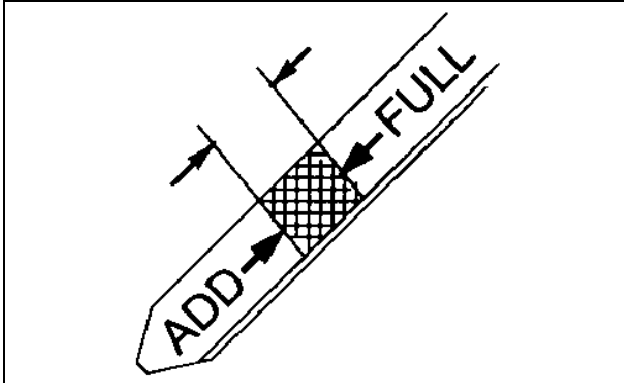

5. Oil must be between add and full marks.
6. Add oil to full mark if necessary. Do not overfill.
7. Install and tighten dipstick. Lower hood.

Break-In Electric PTO Clutch



MX13482

1. Start engine and push throttle lever (A) up to full throttle (r) position.
2. With no load on mower, engage PTO (B) and allow mower to run for 10 seconds.
3. Disengage PTO and wait 10 seconds.
4. Repeat Steps 2 and 3 for 12-15 cycles.
5. PTO clutch is now properly burnished.

Check Machine Safety System

Perform safety system check to make sure electronic safety interlock circuit is functioning properly. Perform all safety system tests.

Checking Tire Pressure



CAUTION: Avoid injury! Explosive separation of tire and rim parts is possible when they are serviced incorrectly:

- Do not attempt to mount a tire without the proper equipment and experience to perform the job.
- Do not inflate the tires above the recommended pressure.
- Do not weld or heat a wheel and tire assembly. Heat can cause an increase in air pressure resulting in an explosion. Welding can structurally weaken or deform the wheel.
- Do not stand in front or over the tire assembly when inflating. Use a clip-on chuck and extension hose long enough to allow you to stand to one side.

1. Check tires for damage.
2. Check tire pressure with an accurate gauge.
3. Add or remove air, if necessary:

Tire Size	Air Pressure
Front: 16 x 7.50	83 kPa (12 psi)
Rear: 24 x 12.00	69 kPa (10 psi)

OPERATING

Daily Operating Checklist

- Test safety systems.
- Check tire pressure.
- Check fuel level.
- Check engine oil level.
- Remove grass and debris from engine compartment and muffler area, before and after operating machine.

Avoid Damage to Plastic and Painted Surfaces

- Do not wipe plastic parts unless rinsed first. (See Correct Cleaning Care in Service-Miscellaneous section.)
- Insect repellent spray may damage plastic and painted surfaces. Do not spray insect repellent near machine.
- Be careful not to spill fuel on machine. Fuel may damage surface. Wipe up spilled fuel immediately.

Operator Station Controls

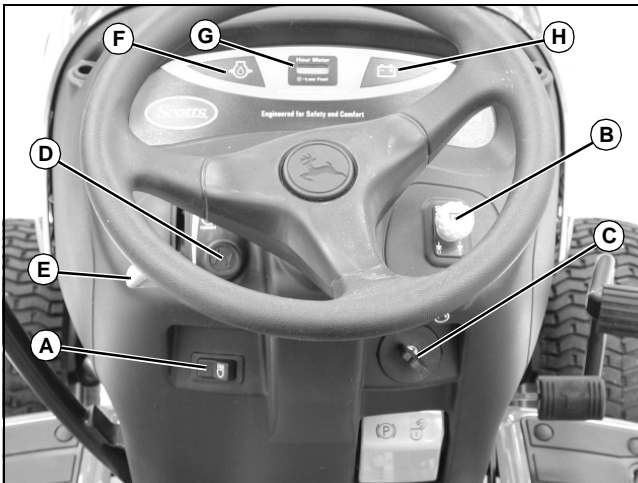

MX13482

- A - Light Switch**
- B - PTO Switch/RIO Switch**
- C - Key Switch**
- D - Choke Knob**
- E - Throttle Lever**
- F - Engine Oil Pressure Light**
- G - Hour Meter**
- H - Battery Discharge Light**

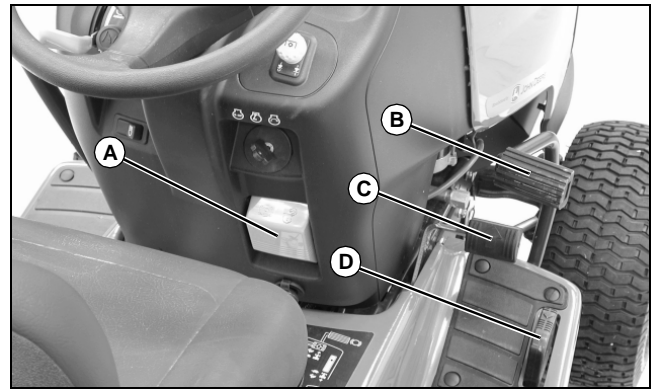

MX13483

- A - Park Brake Lever**
- B - Brake Pedal**
- C - Forward Travel Pedal**
- D - Reverse Travel Pedal**



MX13484

- A - Mower Lift Lever**



MX13485

- A - Cut Height Adjustment Lever**

OPERATING

Adjusting Seat

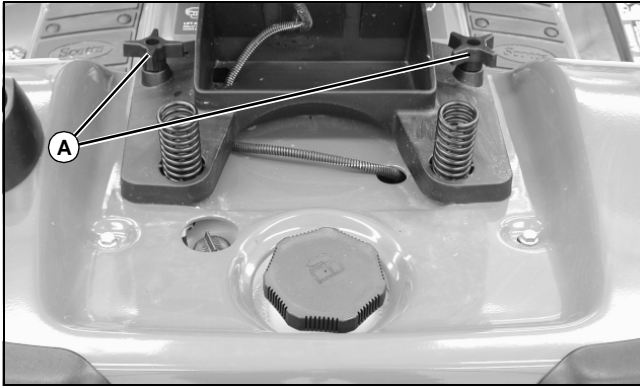

MX13486

1. Tip seat forward and loosen two knobs (A) to slide seat assembly forward or rearward to most comfortable operator position.
2. Tighten knobs after adjustment to keep seat in place.

Adjusting Cutting Height

IMPORTANT: Avoid damage! Lift lever must be in TRANSPORT (upper) position before turning cutting height knob.

NOTE: Adjust mower gage wheels after changing cutting height.

Cutting height can be adjusted from approximately 25–100 mm (1–4 in.).

When lift lever is in transport (upper) position (lift lever completely back), cutting height is approximately 100 mm (4 in.).



MX13485

Knob (A) has cutting height identification numbers embossed in it. To change or attain cutting height desired:

- Pull lift lever completely back to transport (upper) position.
- Turn cutting height knob (A) to desired cutting height

position. Mower will be at this cutting height each time it is lowered.

Adjusting Mower Gage Wheels

CAUTION: Avoid injury! Before adjusting gage wheels:
Stop engine.
Remove key.
Wait for blades to stop.

IMPORTANT: Avoid damage! Mower gage wheels must not ride on ground to support mower weight. Adjust gage wheels each time cutting height is changed.

1. Check machine tire pressure. Inflate tires to correct pressure.
2. Raise mower lift lever to transport (upper) position and adjust cutting height.

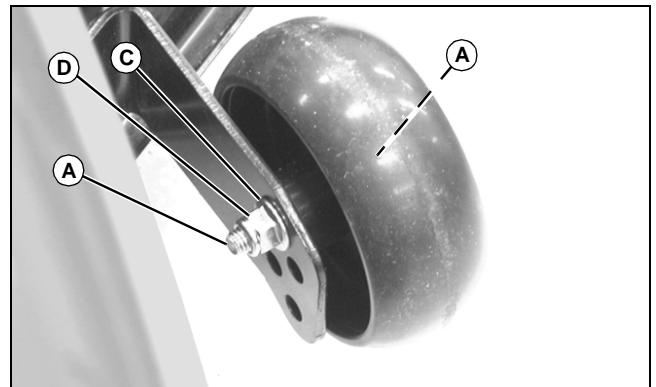

MX13506

3. Remove bolt (A), bushing (B), washer (C), and tighten with nut (D).
4. Move mower gage wheels, one on each side, to one of four holes for desired position.
5. Install bolt and tighten with nut.
6. Move lift lever forward to mowing (lower) position.
7. Bottom of gage wheels should be approximately 6-13 mm (1/4-1/2 in.) from ground when properly adjusted.

OPERATING

Adjusting Mower Level (Side-to-Side)



CAUTION: Avoid injury! Before adjusting gage wheels:

Stop engine.

Remove key.

Wait for blades to stop.

Be careful of sharp edges on mower blades.
Always wear gloves when handling mower blades.

NOTE: A mower leveling gauge (Part Number TY15272) to aid in mower leveling may be obtained through a local John Deere dealer.

1. Park machine safely. (See Parking Safely in the Safety section.)
2. Check tire pressure.
3. Adjust cutting height to 50 mm (2 in.).

NOTE: Mower gage wheels should not contact ground.

4. Put mower lift lever in mowing (lower) position.
5. Turn left blade by hand parallel to machine axle. Hold drive belt and turn right blade parallel to axle.

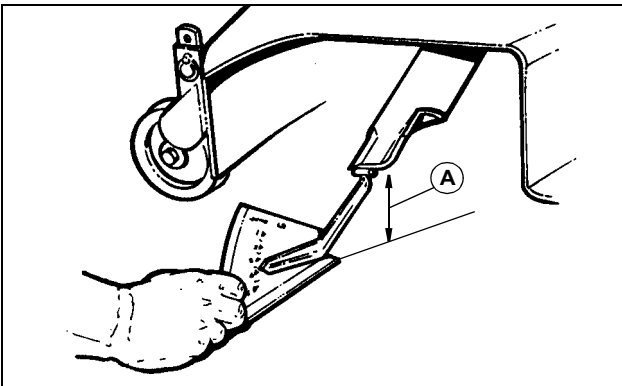

M40161

6. Measure from each outside blade tip (A) to level surface. Difference between measurements must not be more than 3 mm (1/8 in.).

NOTE: Adjustable lift links are on both sides of mower. Cutting height can closely match knob setting by using adjustment on both sides. Do not adjust mower too high or it will not lock in transport (upper) position.

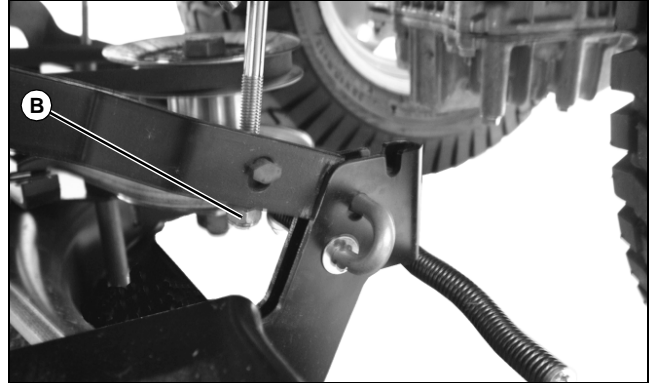

MX13507

7. Turn nut (B), (left side shown): Clockwise to raise left side of mower and counterclockwise to lower left side of mower.
8. Check side-to-side measurements and adjust if necessary.

Adjusting Mower Level (Front-to-Rear)

NOTE: Mower gage wheels should not contact ground during leveling.

1. Park machine safely. (See Parking Safely in the Safety section.)
2. Tire pressure must be correct.
3. Pull lift lever completely back to transport (upper) position.



MX13485

4. Turn mower depth control knob (A) to adjust cutting height to 50 mm (2 in.).
5. Move lift lever forward to mowing (lower) position.
6. Turn left blade so blade tip points straight forward.
7. Hold drive belt and turn right blade straight forward.

OPERATING

8. Measure from front of each blade tip to level surface. Front blade tips must be 6–9 mm (1/4–3/8 in.) lower than rear blade tips or blades will cut grass twice and tips will turn brown.

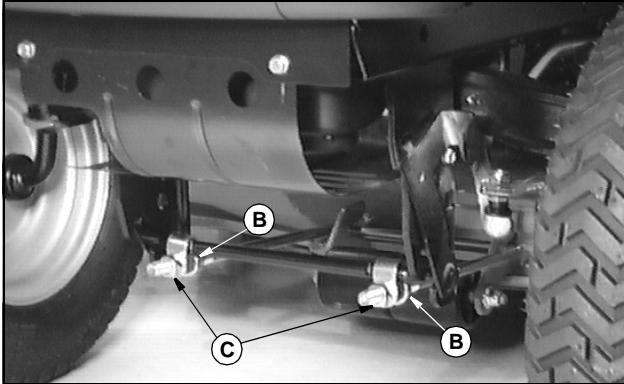

9. Loosen two rear nuts (B) on front lift rod assembly and turn two front nuts (C) clockwise to raise front of mower or counterclockwise to lower front of mower.

10. Tighten rear nuts (B) after adjustment is completed.

11. Check front-to-rear mower measurements and adjust if necessary.

Testing Safety Systems

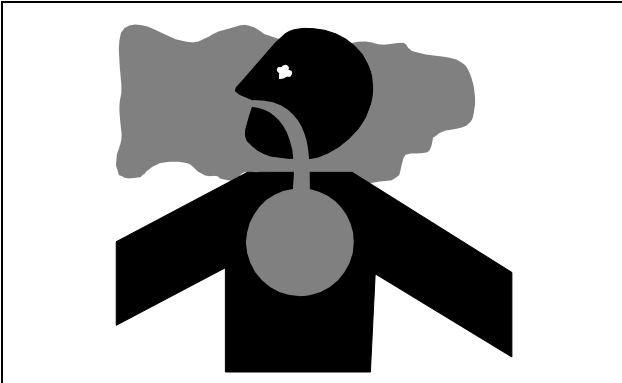

CAUTION: Avoid injury! Engine exhaust fumes contain carbon monoxide and can cause serious illness or death.

Move the vehicle to an outside area before running the engine.

Do not run an engine in an enclosed area without adequate ventilation.

- **Connect a pipe extension to the engine exhaust pipe to direct the exhaust fumes out of the area.**
- **Allow fresh outside air into the work area to clear the exhaust fumes out.**

Use the following checkout procedure to check for normal operation of machine.

If there is a malfunction during one of these procedures, Do not operate machine. **See your John Deere dealer for service.**

Perform these tests in a clear open area. Keep bystanders away.

Testing Indicator Lights

1. Turn key to run position.



2. Look:

- Oil pressure light (A) on must light.
- Battery discharge light (B) will momentarily light, this indicates that system is functioning properly. If light remains on, start engine and move throttle to high idle. Light should go out.

NOTE: Battery discharge light may remain on for several minutes while battery is being charged.

3. If one indicator does not light, replace.

4. If new indicator bulb does not light or no indicators work, see John Deere dealer for service.

OPERATING

Testing Park Brake Switch

1. Operator on seat.

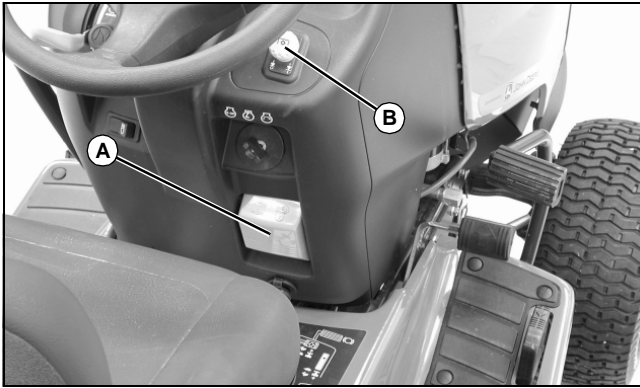

MX13483

2. Unlock park brake (A).
3. Push PTO switch (B) down to disengage.
4. Try to start engine.

Result: Engine must not start. If engine starts, there is a problem with safety interlock circuit.



MX13482

3. Push PTO switch (A) down to disengage.
4. Start engine and move throttle lever (B) to half-speed position.
5. Pull PTO switch (A) up to engage.
6. Move throttle lever (B) to fast speed position.
7. Raise up off of seat. Do not get off machine.

Result: Engine must stop. If engine does not stop, there is a problem with safety interlock circuit.

Testing PTO Switch

1. Operator on seat.

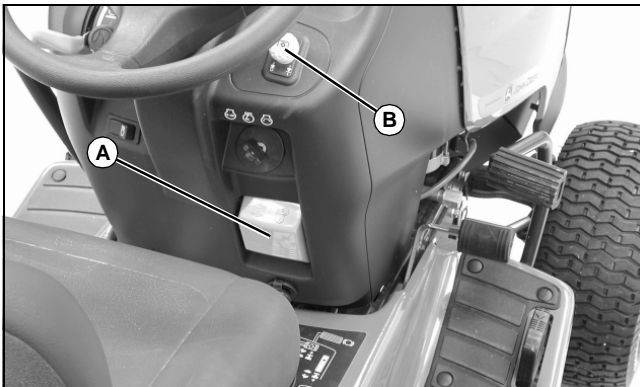

MX13483

2. Lock park brake (A).
3. Pull PTO switch (B) up to engage.
4. Try to start engine.

Result: Engine must not start. If engine starts, there is a problem with safety interlock circuit.

Testing Seat Switch and PTO Switch

1. Operator on seat.
2. Lock park brake.

Testing Seat Switch and Brake Switch

1. Operator on seat.
2. Push brake pedal down.

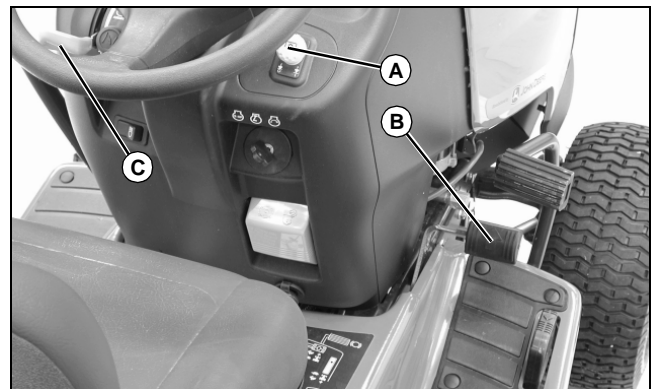

MX13483

3. Push PTO switch (A) down to disengage.
4. Release forward travel pedal (B) to N (neutral) position.
5. Start engine and move throttle lever (C) to fast speed position.
6. Release brake slowly.
7. Raise up off of seat. Do not get off machine.

Result: Engine must stop. If engine does not stop, there is a problem with safety interlock circuit.

OPERATING

Testing Park Brake



MX13483

1. Lock park brake (A).
2. Pull out free-wheeling lever.
3. Try to push machine manually.

Result: Park brake must prevent machine from moving. If machine moves, parking brake needs to be adjusted.

Testing Reverse Implement Option (RIO) Switch



CAUTION: Avoid injury! Before moving rearward, make sure area is clear of bystanders, especially children.

1. Start engine.
2. Engage PTO to start attachment.
3. Look behind machine to be sure there are no bystanders.
4. Begin reverse travel by depressing reverse foot pedal.

Result: Attachment and engine should stop operation. If attachment or engine continues to operate while machine travels in reverse, do not continue to operate attachment. See John Deere dealer for service.

Using Park Brake

Locking Park Brake:



CAUTION: Avoid injury! Always lock park brake before getting off machine or leaving machine unattended.

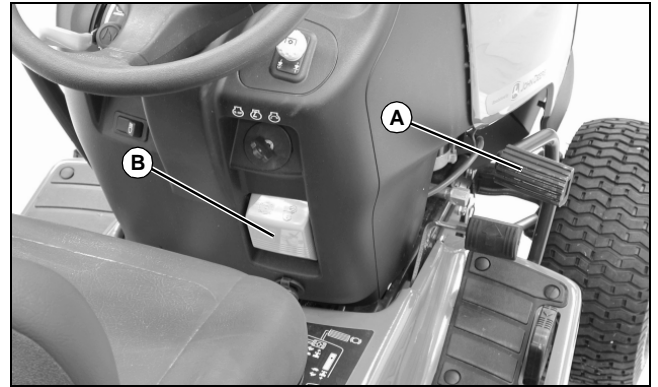

MX13483

1. Push brake pedal (A) completely down.
2. Lift park brake lever (B) up.
3. Release pedal and park brake lever. Pedal should stay down and park brake lever should stay locked in up position.

Unlocking Park Brake:

1. Push and hold brake pedal (B) down.
2. Push park brake lever (A) down to unlock park brake.
3. Release pedal.

Using Headlights



MX13482

Push right side of light switch (A) to turn headlights on.
Push left side of light switch to turn headlights off.

OPERATING

Checking Indicator Lights and Hour Meter



- Battery discharge light (A) should go out when throttle lever is moved to high idle/mowing position. Battery discharge light may remain on for several minutes while battery is being charged.

- Oil pressure light (B) will come on when engine starts and should go out within 5 seconds.

If indicator lights stay on longer than given time, stop engine.

- Hour meter (C) shows number of hours engine has run. To display hours, key must be in on position. Check hour meter daily to see what services need to be done. (See Service Interval Chart in this manual and Maintenance Schedule in engine owner's manual.)

Starting Engine



CAUTION: Avoid injury! Start engine only outdoors or in a well ventilated place. Exhaust fumes are dangerous.

IMPORTANT: Avoid damage! Do not operate starter more than 20 seconds at a time. If engine does not start: Wait two minutes before trying again. See Troubleshooting section.

NOTE: Engine will not start unless: PTO switch is disengaged, park brake is locked or brake pedal pushed down.

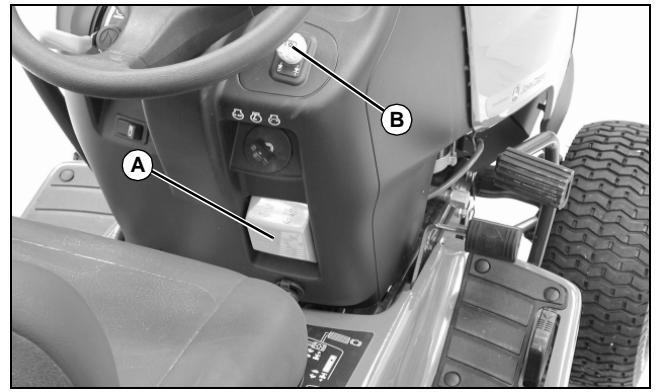

1. Lock park brake (A).
2. Push PTO switch (B) down to disengage.

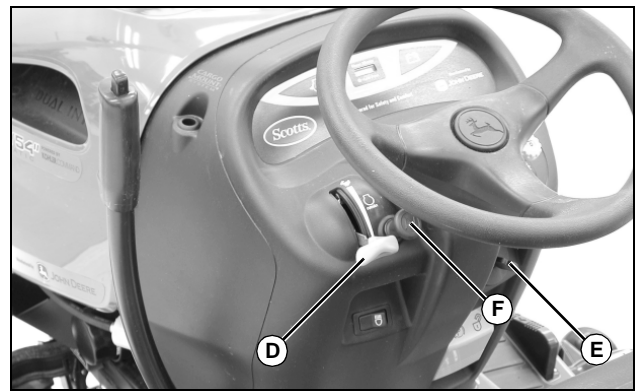

3. Pull choke knob (F) out to on position.
4. Move throttle lever (D) to half-speed position.
5. Turn key (E) to start position.
6. When engine starts, release key to run position.
7. Check starting conditions:
 - **If engine is cold:** Gradually return choke to off position after engine starts and warms up.
 - **If engine is warm:** Return choke to off position as soon as engine starts.
8. Let engine run for a couple of minutes to warm-up before operating machine.

OPERATING

Idling Engine

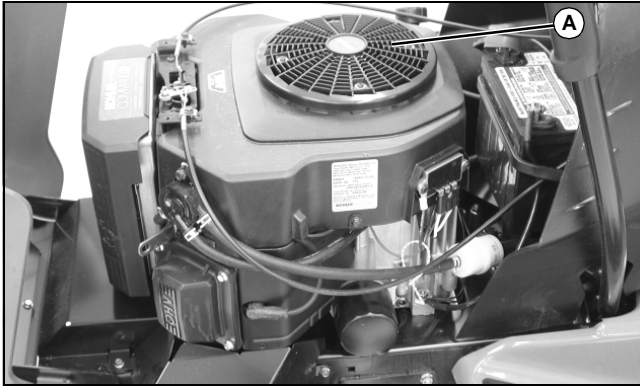

MX13509

Engine is air-cooled and needs a large volume of air to keep cool. Keep air intake screen (A) on top of engine clean.

Stopping Engine

IMPORTANT: Avoid damage! Failure to remove grass and debris from the engine and muffler areas of the machine can result in fires. Grass and debris can collect in the engine compartment and around the muffler while mowing. When mowing is completed, clean the engine compartment and around the muffler of all grass and debris.



MX13482

1. Move throttle lever (A) midway between slow and fast positions. Let engine run a minimum of 15 seconds.
2. Turn key (B) to off position.
3. Remove key.
4. Lock park brake.

Using and Stopping Automatic Transmission



CAUTION: Avoid injury! Before moving forward or rearward, make sure area is clear of bystanders, especially children.

Disengage mower before backing up.

To Travel Forward:

1. Unlock park brake.



MX13483

2. Push down forward travel pedal (A).

To Travel in Reverse:

NOTE: Engine and any operating attachment will stop as reverse pedal is depressed with attachment engaged.

1. Stop machine.
2. Push PTO knob down to off position to disengage attachment.
3. Look behind machine to be sure there are no bystanders nearby.

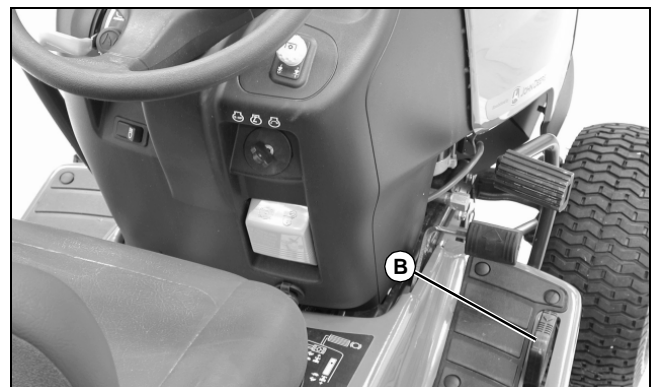

MX13483

4. Push down reverse travel pedal (B).

OPERATING

For Emergency Stopping:

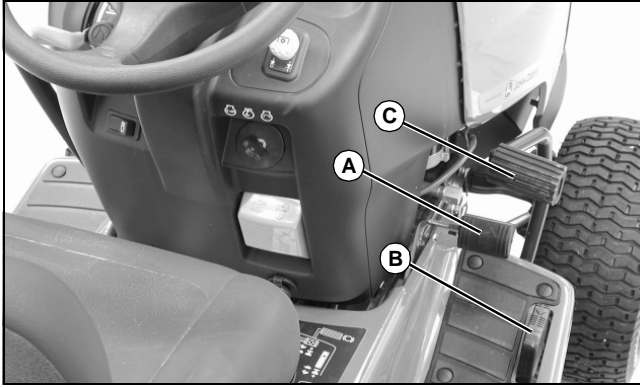

MX13483

1. Push down on brake pedal (C). Travel pedals (A and B) will return to neutral position.

Using Lift Lever to Raise and Lower Mower

Check two different lift lever positions before operation:

- Transport (upper) position: Raises mower for transport.
- Mowing (lower) position: Maintains cutting height set by mower height control yet allows mower to float over uneven terrain.

To put mower in mowing (lower) position:



MX13484

1. Pull lift lever (A) back slightly.
2. Push in button (B).
3. Push lever forward until it latches down.

To put mower in transport (upper) position:

1. Push down on lift lever (A) slightly.
2. Push in button (B).
3. Pull lever back until it latches.

Engaging Mower

IMPORTANT: Avoid damage! Operate mower at high idle/mowing when mowing or after mower blades are engaged.

Machine may require 2-3 minutes warm-up period before engaging mower.

1. Start engine.



MX13482

2. Move throttle lever (A) to fast position.
3. Lower mower to cutting height.
4. Pull PTO switch (B) up to engage mower.

NOTE: Any operating attachment and engine will stop as REVERSE foot pedal is depressed with attachment engaged.

5. Disengage PTO before shifting to reverse.

Disengaging Mower



MX13482

Push PTO switch (A) down to disengage mower.

If an object is hit with mower while mowing, stop mower and engine immediately. Inspect mower for damage.

OPERATING

Dismounting to Inspect or Unplug Mower or Optional Bagger

CAUTION: Avoid injury! Do following steps before dismounting to inspect or unplug mower or bagger.

1. Stop machine.
2. Push PTO switch down to disengage mower.
3. Move throttle lever midway between slow and fast positions. Let engine run a minimum of 15 seconds.
4. Lower mower to ground.
5. Lock park brake.
6. Stop engine.
7. Remove key.
8. Wait for all moving parts to stop.

Pushing Machine

IMPORTANT: Avoid damage! Do not tow machine.

To move machine when engine is stopped:



MX13483

1. Unlock park brake (A).



MX13510

2. Pull out on free-wheeling lever (B).
3. Push machine to desired location.

NOTE: Push free-wheeling lever (B) in before operating machine.

Using Reverse Implement Option

CAUTION: Avoid injury! Before moving forward or rearward, make sure area is clear of bystanders, especially children.

NOTE: Operating mower while backing up is strongly discouraged. Reverse Implement Option should be used only when operating another attachment or when operator deems it necessary to reposition machine with mower engaged.

1. Stop machine forward travel with attachment still engaged.
2. Look behind machine to be sure there are no bystanders.



MX13482

3. Lift and hold PTO knob (A) up past PTO engagement position to activate reverse implement position while depressing reverse foot pedal slightly.

OPERATING

NOTE: If engine and attachment stop while repositioning machine, return PTO knob to off position and restart machine. (See Starting Engine in this section.) Begin again with Step 2.

4. As machine begins to move backward, release PTO knob and reposition machine.
5. Resume forward travel. Attachment should continue operating.
6. Repeat Steps 1 through 5 to reposition machine again.

Using Front Weights



CAUTION: Avoid injury! Machine front wheel weights improve stability in most slope operation.

Add front wheel weights for better front-end stability and steering when using a rear mounted attachment or pulling a cart.

NOTE: Before installing wheel weights on machine, make sure that tire valve stems are facing inside.

Install front wheel weights for better stability and steering control when using equipment such as rear-mounted grass bagger or dumpcart.

Remove front wheel weights when not required.

Using Rear Wheel Weights

IMPORTANT: Avoid damage! When adding weight to rear of machine, use wheel weights only, a maximum of 34 kg (75 lb) for each wheel.

Use of rear wheel weights is recommended when an attachment, such as snowthrower or blade is used.

Using Tire Chains

Tire chains are recommended for use with snowthrower and, under certain conditions; front blade.

See your Authorized Service Center for tire chains.

Transporting Machine on Trailer

Be sure trailer has all the necessary lights and signs required by law.



CAUTION: Avoid injury! Use extra care when loading or unloading the machine into a trailer or truck.

IMPORTANT: Avoid damage! Transmission damage may occur if the machine is towed or moved incorrectly:

- Move machine by hand only.
- Do not use another vehicle to move unit.
- Do not tow unit.

1. Drive forward onto heavy-duty trailer.
2. Lower mower to trailer deck.
3. Lock park brake.
4. Machines with fuel shut-off: Turn fuel shut-off to off position.
5. Fasten machine to trailer with heavy-duty straps, chains, or cables. Both front and rear straps must be directed down and outward from machine.
6. Strap down hood.

REPLACEMENT PARTS

Service Literature

If you would like a copy of the Parts Catalog or Technical Manual for this machine call:

- **U.S. & Canada:** 1-800-522-7448.
- **All Other Regions:** Your John Deere dealer.

Parts

We recommend John Deere quality parts and lubricants, available at your John Deere dealer.

Part numbers may change, use part numbers listed below when you order. If a number changes, your dealer will have the latest number.

When you order parts, your John Deere dealer needs your machine serial number and engine serial number. These are the numbers that you have recorded in the Introduction section of this manual.

Parts for Machine

Item	Part Number
Air Cleaner:	
Foam	M133094
Paper	M133095
Fuel Filter	M132403
Oil Filter	AM125424
Spark Plug	Champion - RC12YC
Battery	AM121593
Fuse-15 amp	99M7065
Leveling Gauge	TY15272
Steering Wheel Assembly	AM121918
Seat	AM124425
Front Lift Rod Assembly:	
Rod	M132735
Welded Pivot	AM119811
Clevis (2)	M113014
Spacers (2)	M110875
Lock Nuts (2)	M85540
Hex Nuts (2)	14M7275

Item	Part Number
Headlight Bulb (2 required)	AD2062R (#1156)
Fuel Cap	AM115497
Ignition Key	M127340
Throttle Cable	AM130226
Choke Cable	AM130319
Seat Spring	M110439
Muffler	AM126000

Parts for Mower

Item	Part Number
Primary Belt (PTO clutch to upper mower sheave)	BM19742
Secondary Belt (lower mower sheave to blade spindles)	M118685
Blade, Standard	BM19741 (Special 3-Pack)
Blade, High Lift	M135590
Discharge Chute Assembly:	
Chute	M123859
Chute Pin	M112899
Chute Spring	M83410
Chute Hinge	M118246
Gage Wheel Assembly:	
Gage Wheels (2 required)	M111489
Bolts	19M7274
Nuts	14M7396
Bushings	M111491
Washers	M110698

(Part numbers are subject to change without notice. Part Numbers may be different outside the U.S.A.)

SERVICE INTERVAL CHART

Servicing Your Machine

Please use the following timetables to perform routine maintenance on machine. Service procedures included in this manual but not on this chart are to be performed on an as needed basis.

IMPORTANT: Avoid damage! If operating mower in extreme heat, dust or other severe conditions, service more often than shown below.

After the first 5 hours of operation (break-in period):

- Check/tighten all hardware
- Check wheel bolt torque (also check again at 50 hours for break-in, then every 200 hours)
- Change engine oil (also change oil again at 50 hours for break-in, then every 100 hours, or every season.
- Lubricate front steering spindles, wheel bearings and axle pivot

Service to be Performed	Intervals in Hours					
	Before Each Use	Every 25	Every 50	Every 100	Every 200	Annually or Every 500
Test safety systems	X					
Check fuel level	X					
Check engine oil level	X					
In severe conditions lubricate all mower spindles	X					
In severe conditions check and clean engine air cleaner	X					
Check tire pressure	X					
Check cutting height	X					
Check/tighten hardware	X					
Change engine oil				X		
Change engine oil filter					X	
Change/clean engine air cleaner pre-cleaner		X				
Replace air cleaner element				X		
Replace fuel filter					X	
Lubricate mower spindles		X				
Clean battery			X			
Lubricate front steering spindles, wheel bearings and axle pivot		X				
Check automatic transmission oil level		X				
Clean cooling shrouds and cooling areas				X		
Check spark plugs					X	

After Each Use

- Clean debris from engine, especially air intake screen.
- Remove belt shields, clean belt area, check belts. Be

sure shields are secure.

- Clean under mower. Inspect blades.
- Check for loose, missing, or damaged parts.

SERVICE LUBRICATION

Grease

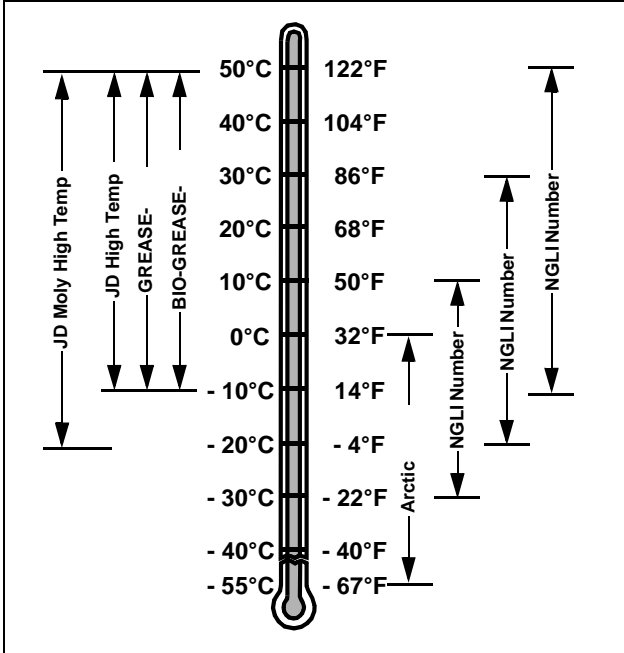

TS1417

Use grease based on expected air temperature range during service interval.

Preferred greases:

- John Deere Moly High Temperature EP Grease.
- John Deere High Temperature EP Grease.
- John Deere GREASE-GARD™

Other greases may be used are:

- SAE Multipurpose EP Grease with 3 to 5 percent molybdenum disulfide.
- SAE Multipurpose EP Grease.
- Greases meeting Military Specification MIL-G-10924C may be used as arctic grease.

Lubricating Mower Spindles

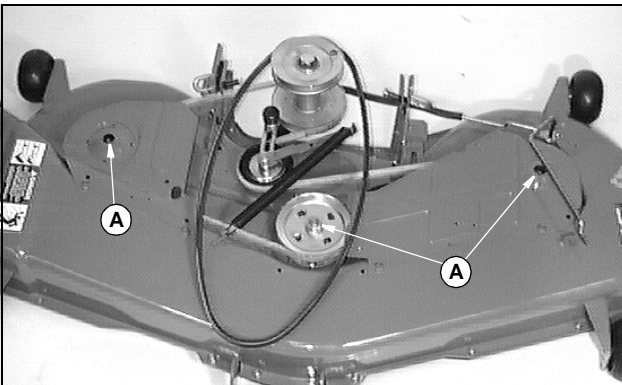

M88572

Lubricate three mower spindles grease fittings (A) with multipurpose grease or an equivalent.

Lubricating Front Wheel Spindles, Wheel Bearings and Front Axle Pivot

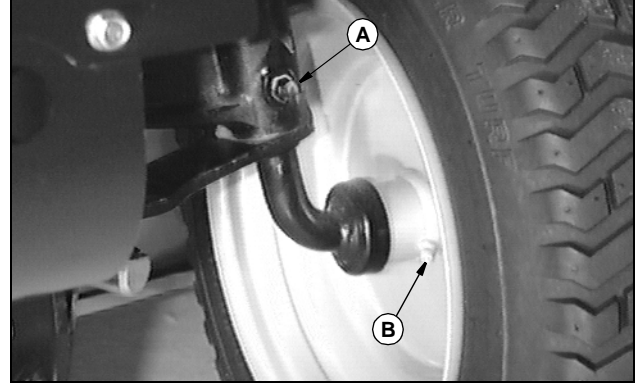

M88584

Lubricate front wheel spindles (A), wheel bearings (B), one on each side of machine, and front axle pivot (C) with one or two shots of multipurpose grease or an equivalent.

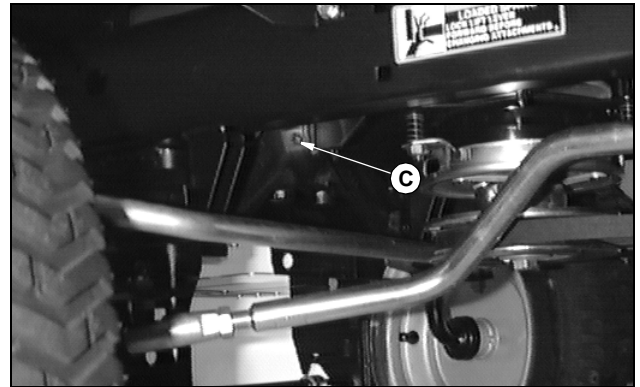

M92886

Turn wheels to distribute grease to spindles.

SERVICE ENGINE

Avoid Fumes



CAUTION: Avoid injury! Sickness or possible death from engine exhaust fumes.

Do not run an engine in an enclosed area without:

- An exhaust pipe extension connected to exhaust pipe of engine directing exhaust fumes out of area.
- Doors and windows open allowing fresh outside air into area and getting exhaust fumes out.

Engine Warranty Maintenance Statement

Maintenance, repair, or replacement of emission control devices and systems on this engine, which are being done at customer's expense, may be performed by any nonroad engine repair establishment or individual. Warranty repairs must be performed by an authorized John Deere dealer.

Adjusting Carburetor

NOTE: Carburetor is calibrated by engine manufacturer and should not require any adjustments.

If engine is operated at altitudes above 1829 m (6,000 ft.), some carburetors may require a special high altitude main jet. See John Deere dealer.

Possible engine surging will occur at high rpm with no load (with transmission in N (neutral) and mower blade engagement lever disengaged). This is a normal condition due to emission control system.

If engine is hard to start or runs rough, check Troubleshooting section of this manual.

After performing checks in troubleshooting section and engine is still not performing correctly, contact John Deere dealer.

Engine Oil

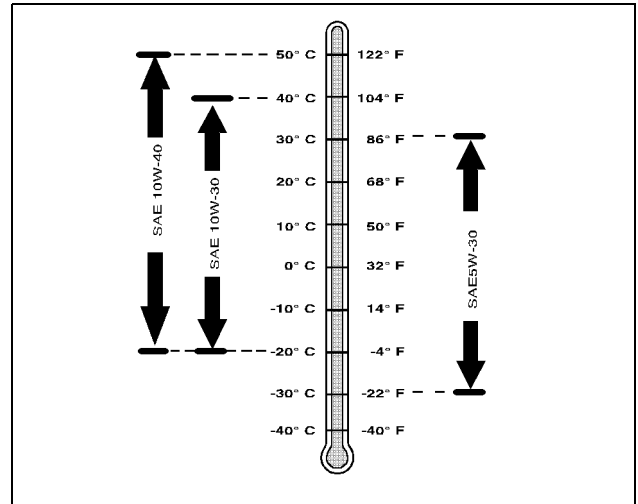

Use oil viscosity based on expected air temperature range during period between oil changes.

Preferred John Deere oils:

- TORQ-GARD®
- PLUS-4®

Other oils may be used if above John Deere oils are not available, provided they meet following specification:

- API Service Classification SG or higher

Checking Engine Oil Level

IMPORTANT: Avoid damage! Do not run engine if oil level is below add mark.

1. Park machine safely. (See Parking Safely in the Safety section.)
2. Allow engine to cool. Lift hood.
3. Clean area around dipstick to prevent debris from falling into crankcase.

SERVICE ENGINE



MX13511

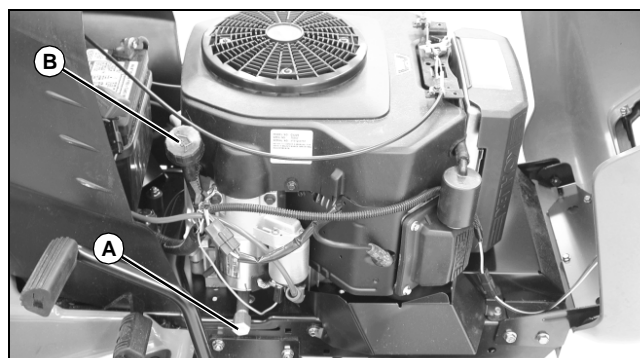

MX13511

4. Remove dipstick (A). Wipe with clean cloth.
5. Insert dipstick into tube and rest oil fill cap on tube. Do not thread cap onto tube.
6. Remove dipstick and check oil level.

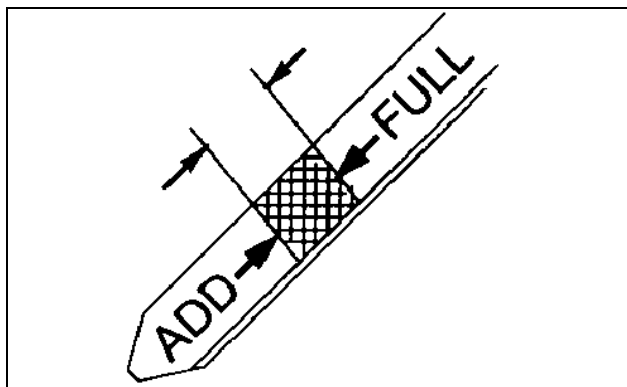

7. Oil must be between add and full marks.
8. Add oil to full mark if necessary. Do not overfill.
9. Install and tighten dipstick. Lower hood.

Changing Engine Oil



CAUTION: Avoid injury! Hot Engine and Hot Oil can cause severe burns. Allow engine temperature to drop from hot to warm level before attempting to change oil.

1. Run engine to warm oil.
2. Park machine safely. (See Parking Safely in the Safety section.)
3. Wipe debris and dirt from around dipstick.

4. Put drain pan under drain extension (A).
5. Remove drain plug (A) and drain oil into oil drain pan.
6. Replace drain plug. Tighten to 13.6 N•m (10 ft-lb).
7. Remove dipstick (B) and fill with new oil of recommended grade.

- Approximate engine oil capacity: 2.1 L (2 qt)

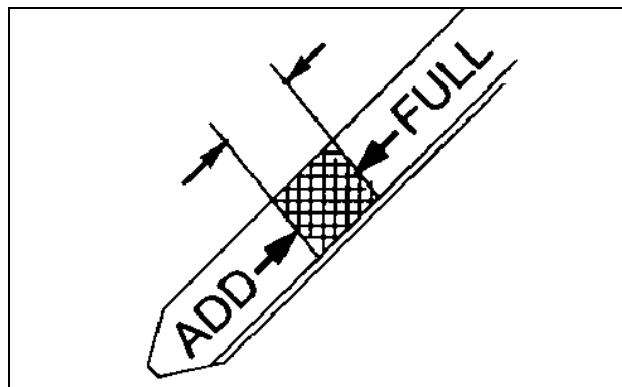

8. Install dipstick and then remove to check oil level. Oil level must be between add and full marks. Do not overfill.
9. Install and tighten dipstick.
10. Start engine and check for oil leaks. Correct any leaks before operating.

Changing Engine Oil Filter



CAUTION: Avoid injury! Hot engine and hot oil can cause severe burns. Allow engine temperature to drop from hot to warm level before attempting to change oil and filter.

To prevent accidental starting, remove wire from spark plugs and disconnect battery at negative terminal before servicing engine.

1. Park machine safely. (See Parking Safely in the Safety section.)

SERVICE ENGINE

2. Drain engine oil and replace with fresh oil.
3. Wipe debris and dirt from around oil filter.



MX13509

4. Put a small shallow pan or funnel under oil filter (A) to catch oil drained from filter.
5. Remove old filter (A) and wipe off filter tray with a clean cloth.
6. Lightly oil filter gasket with fresh, clean oil.
7. Install replacement oil filter. Turn oil filter to right (clockwise) until rubber gasket contacts filter adapter. Tighten filter an additional one-half turn.
8. Start and run engine at idle to check for leaks. Stop engine.
9. Check oil level. (See Checking Engine Oil Level in this section.)
10. Add oil if required. (See Engine Oil in this section.)

Cleaning Air Intake Screen and Engine Fins

IMPORTANT: Avoid damage! Which can result from overheating:

Keep air intake screen free of dust.

Keep cooling fins free of dust.

Keep cooling shrouds in place.

1. Park machine safely. (See Parking Safely in the Safety section.)
2. Lift hood.

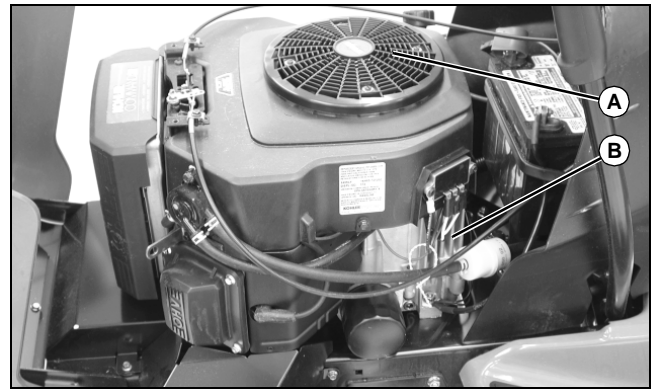

MX13509

3. Clean air intake screen (A), oil cooler fins (B) and external surfaces, with rag, brush, vacuum or compressed air. Lower hood.

Checking and Cleaning Air Cleaner Elements

NOTE: It may be necessary to check air filter more frequently if operating machine in dusty conditions.

1. Lift hood.
2. Clean any dirt and debris from air cleaner area before removing cover.



MX13509

3. Remove cover (A).

SERVICE ENGINE

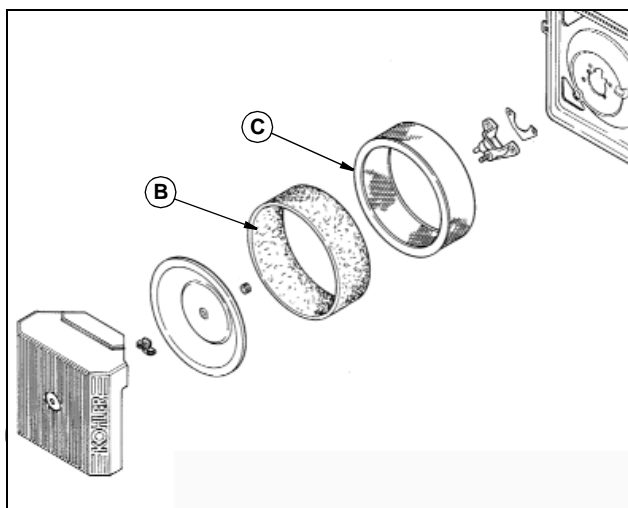

M88594

4. Inspect foam precleaner (B) and element (C) without removing.
 5. If precleaner (B) is dirty, carefully remove from filter, leaving element (C) in air cleaner housing.
- NOTE: Do not wash paper element.**
6. Wash precleaner (B) in a solution of warm water and liquid detergent.
 7. Rinse precleaner thoroughly. Squeeze out excess water in a dry cloth until precleaner is completely dry.
 8. Put approximately 30 ml. (1 oz.) of clean engine oil onto precleaner. Squeeze precleaner to distribute oil evenly. Squeeze out excess oil with a clean cloth.

IMPORTANT: Avoid damage! A damaged paper element (C) can allow dirt into carburetor and can cause poor engine performance, engine damage or failure:

- Do not attempt to clean paper element by tapping against another object.
- Replace element only if very dirty.
- Do not use pressurized air to clean element.
- If element is damaged or seal is cracked, replace.

9. Remove and replace filter element (C) only if damaged or very dirty.
10. Carefully remove element (C) from air cleaner housing. Replace with a new element.
11. Carefully clean air cleaner housing. Prevent any dirt from falling into carburetor.
12. Install precleaner onto new filter element and install into air cleaner housing.
13. Install cover. Lower hood.

Checking Spark Plugs



CAUTION: Avoid injury! Before removing spark plugs, Stop engine and wait until engine is cool.

1. Stop engine. Remove key. Lift hood.



MX13511

2. Disconnect spark plug wires (A), one on each side, and remove spark plugs.
3. Clean spark plugs carefully with a wire brush.



M33906

4. Check plug gap with a wire feeler gauge.
 - Gap should be 0.76 mm (0.030 in.)
5. To change gap, move outer electrode.
6. Install and tighten spark plug(s).
 - Tighten plug(s) to: 24.4/29.8 N•m (18/22 lb-ft).
7. Connect spark plug wires.
8. Lower hood.

SERVICE ENGINE

Replacing Fuel Filter



CAUTION: Avoid injury! Keep cigarettes, sparks, and flames away from fuel system. Make sure engine is cool to touch.

IMPORTANT: Avoid damage! When disconnecting fuel tank hose from filter, be sure to hold hose above fuel tank level so fuel does not run out.

NOTE: Change filter when fuel is low in fuel tank.

1. Park machine safely. (See Parking Safely in the Safety section.)
2. Let engine cool. Lift hood.

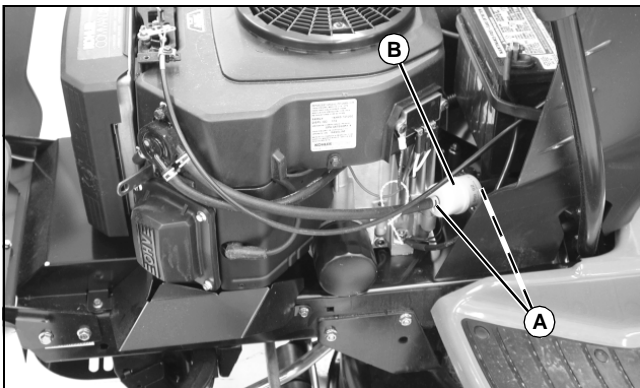

MX13509

3. Using pliers, slide hose clamps (A) away from fuel filter (B).
4. Disconnect hoses from filter.
5. Connect hoses to new filter.
6. Install clamps and check for leaks.
7. Lower hood.

SERVICE TRANSMISSION

Checking Automatic Transmission Fluid Level

1. Let engine cool.
2. Allow oil in transmission to cool before checking.

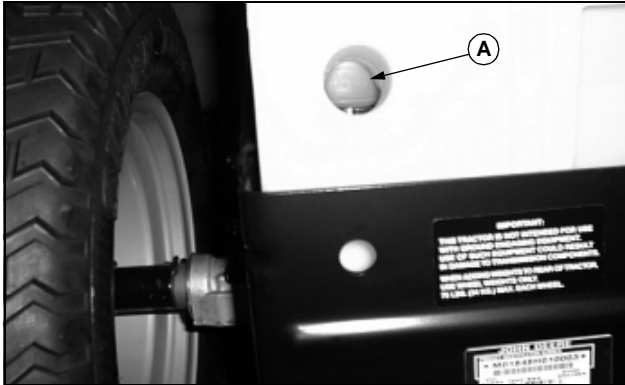

M63559

3. On rear of machine, there is a sight hole (A) through left rear side of fuel tank. Transmission reservoir can be seen through sight hole.

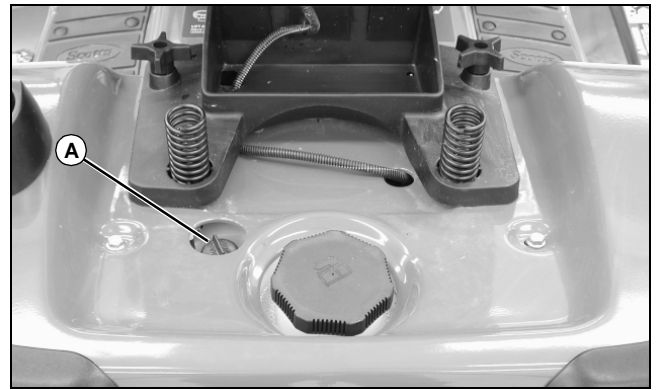

MX13486

2. Remove cap (A) from transmission reservoir. Cap is located under seat and left of fuel cap.
3. Fill to correct level using specified transmission oil (motor oil). Do not overfill.

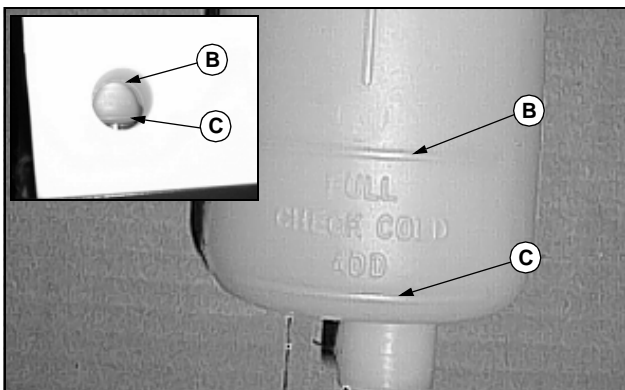

M63557a

4. Check full (B) and add (C) marks on reservoir bottle which will indicate if fluid needs to be added.
5. Add transmission fluid if necessary.

Adding Automatic Transmission Fluid

1. Tip seat forward and slide seat suspension completely forward.

SERVICE MOWER

Removing Mower



CAUTION: Avoid injury! Released spring tension in components can cause injury.

Lock lift lever before removing mower.

Make sure to grip drive belt tension rod tightly and release slowly.

NOTE: Removing mower is easier if machine wheels are turned to one side.

1. Park machine safely. (See Parking Safely in the Safety section.)
2. Raise mower to transport (upper) position using lift lever.

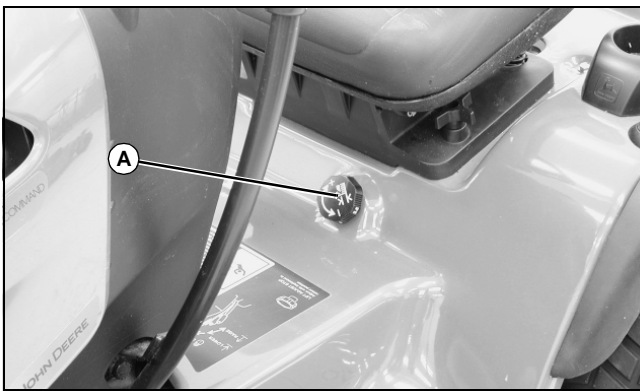

MX13485

3. Set cutting height knob (A) to 25 mm (1 in.).
4. Put wood blocks under each side of mower.
5. Lower mower to mowing (lower) position, bring mower down onto blocks.

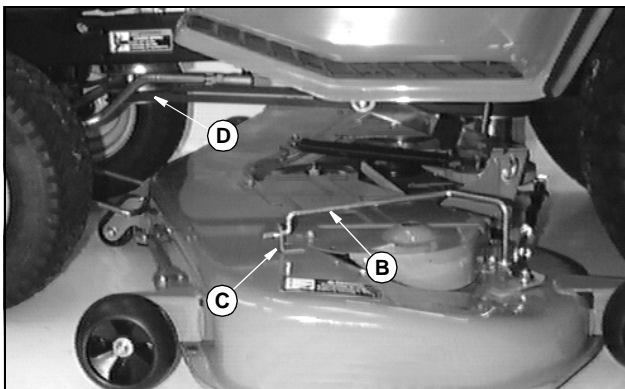

M88579

Picture Note: 54-Inch Mower Shown

6. Release drive belt tension rod (B) from bracket (C).
7. Remove belt from engine drive sheave (D).

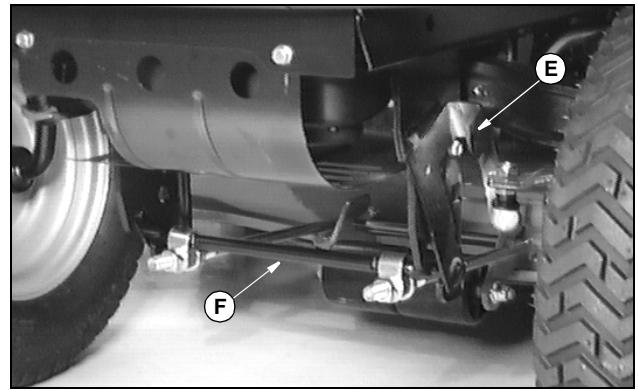

M88578

8. Pull out and push down on lever (E) to release front lift rod assembly (F) and remove from front of mower.



M88577

Picture Note: 54-Inch Mower Shown

9. Disconnect draft arms, one on each side, by pulling spring loaded J-pins (G) out.
10. Put mower lift lever in transport (upper) position.
11. Slide mower out from under machine.

Installing Mower



CAUTION: Avoid injury! Released spring tension in components can cause injury.

Lock lift lever before removing mower.

Make sure to grip drive belt tension rod tightly and release slowly.

NOTE: Installing mower is easier if machine wheels are turned to one side.

1. Park machine safely. (See Parking Safely in the Safety section.)
2. Raise mower lift lever to transport (upper) position.
3. Slide mower under machine and line up mower lift brackets with rear draft arms.

SERVICE MOWER

- Put wood blocks under each side of mower.
- Put mower lift lever in mowing (lower) position.



M88577

Picture Note: 54-Inch Mower Shown

- Install rear draft arms, one on each side of machine, to mower lift brackets with spring loaded J-pins (A).

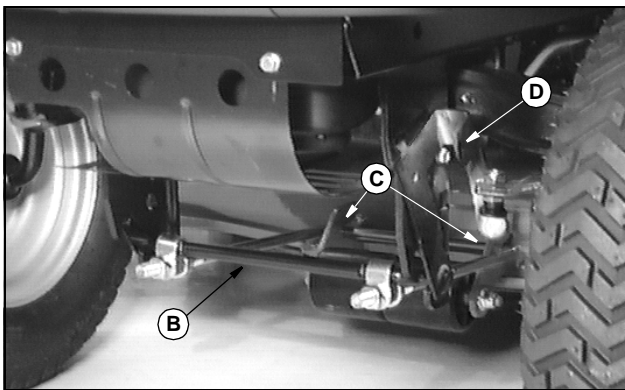

M88578

- Put front lift rod assembly (B) in slotted brackets (C) on mower and install front lift rod assembly to front of machine frame.
- Push up on lever (D) and lock into machine frame.

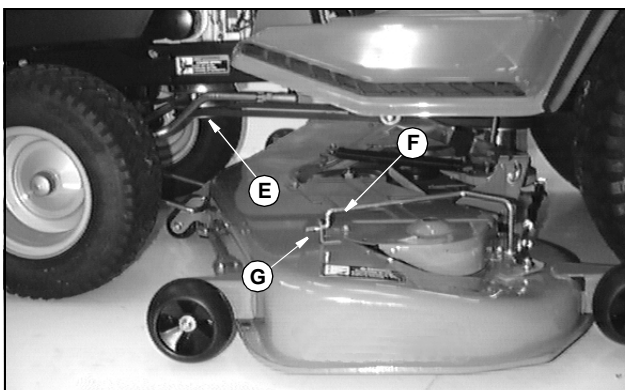

M88579

Picture Note: 54-Inch Mower Shown

- Put mower drive belt (E) on engine drive sheave.
- Push drive belt tension rod (F) into bracket (G).

- Raise mower lift lever to transport (upper) position.
- Remove wood blocks from both sides of mower.
- Level mower.

Replacing Mower Drive Belt



CAUTION: Avoid injury! Before replacing mower drive belt:

Stop engine.

Remove key.

Wait for all moving parts to stop.

Wear gloves when replacing belt.

- Park machine safely. (See Parking Safely in the Safety section.)
- Remove mower.

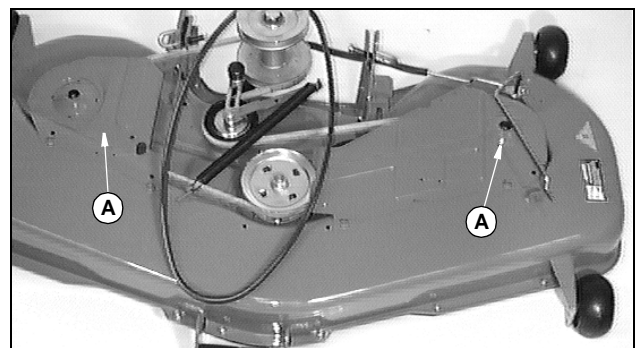

M88572

Picture Note: 54-Inch Mower Shown

- Remove three cap screws and belt shields (A).

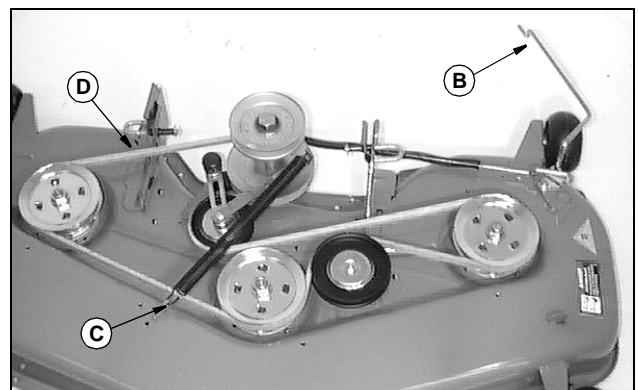

M88595

Picture Note: 48-Inch Mower Shown

- Put drive belt tension rod (B) in released position as shown and disconnect idler spring (C).
- Remove mower belt (D).

SERVICE MOWER

6. Clean upper mower and sheaves.
7. Inspect belt for wear or damage; replace as necessary.
8. Install belt (D) on mower as shown.
9. Connect idler spring (C).
10. Install two belt shields and fasten with three cap screws.
11. Install mower.

Adjusting Mower Drive Belt Tension

1. Park machine safely. (See Parking Safely in the Safety section.)
2. Remove mower.
3. Remove three cap screws and belt shields.

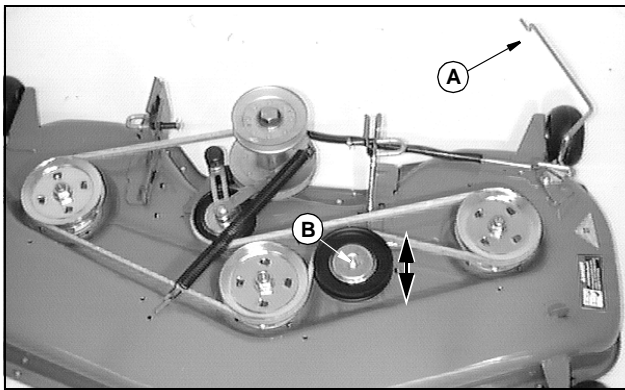

M88595

Picture Note: 48-Inch Mower Shown

4. Leave drive belt tension rod (A) in open position.
5. Loosen nut (B) on flat idler.
6. Slide flat idler forward or back to get desired belt tightness and tighten flat idler nut.
7. Install two belt shields and fasten with three cap screws.
8. Install mower.

Servicing Mower Blades



CAUTION: Avoid injury! Be careful of sharp edges on mower blades. Always wear gloves when handling mower blades.

Removing Mower Blades

1. Raise mower to gain access to mower blades. If necessary, remove mower.
2. Using a wooden block, prevent mower blades from spinning.

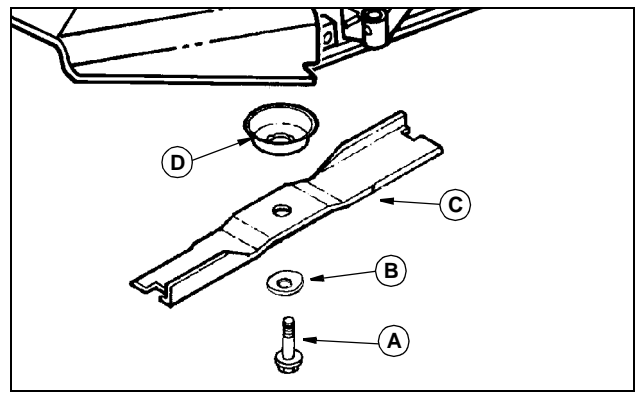

M88116

3. Loosen cap screw (A).
4. Remove cap screw (A), round blade washer (B), blade (C) and deflector cup (D).
5. Inspect blades; sharpen/balance or replace as necessary.

Installing Mower Blades

1. Lightly lubricate cap screw threads with a general purpose grease or oil. This lubrication is to prevent rusting and seizing.

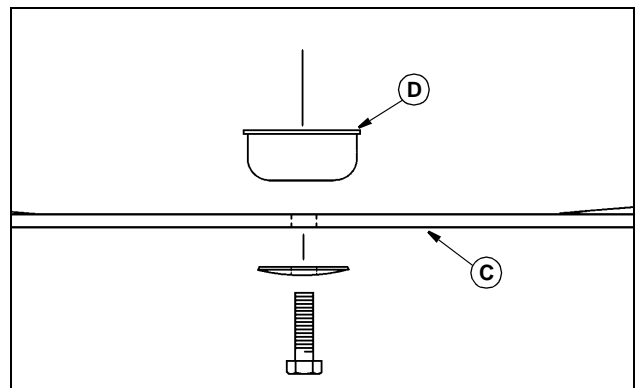

M88112c

2. Install deflector cup (D) on spindle.
3. Position mower blade (C) with cutting edge towards ground onto mower spindle.

SERVICE MOWER

IMPORTANT: Avoid damage! Some blade washers (B) have two index marks (E). When these blade washers are installed, index marks must be visible. This will indicate that cup side of washer is toward blade (C).

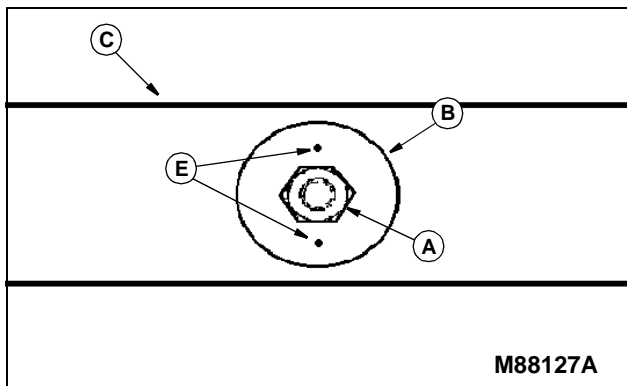

4. Install blade washers (B) and make sure two index marks (E) are visible when installed.
5. Install and tighten cap screw (A) by hand until mower blade is in full contact (fully seated) with spindle.
6. With mower blade blocked, to prevent spinning, tighten cap screw (A) to 84 N•m (62 lb-ft).

Sharpening Blades

CAUTION: Avoid injury! Wear goggles and gloves when handling blades.

1. Sharpen blades with grinder, hand file or electric blade sharpener.

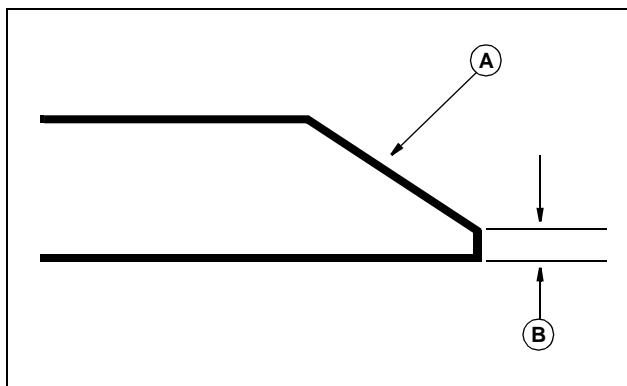

2. Keep original bevel (A) when grinding.
3. Blade should have 0.40 mm (1/64 in.) cutting edge (B).

Balancing Blades

CAUTION: Avoid injury! Wear goggles and gloves when handling blades.

1. Clean blade.

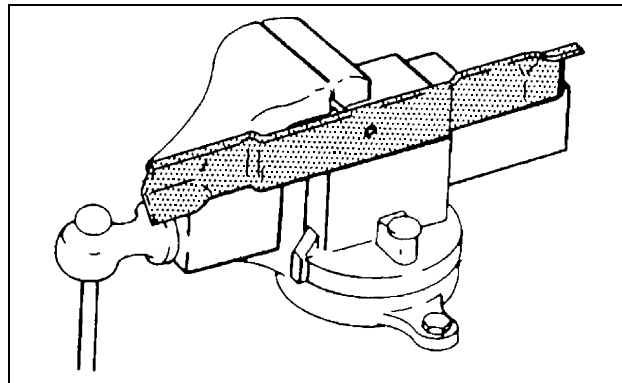

2. Put blade on nail in vise or on vertical wall stud. Turn blade to horizontal position.
3. If blade is not balanced, heavy end of blade will drop.
4. Grind bevel of heavy end. Do not change bevel.

SERVICE ELECTRICAL

WARNING: Battery posts, terminals and related accessories contain lead and lead components, chemicals known to the State of California to cause cancer and reproductive harm. **Wash hands after handling.**

Service the Battery Safely

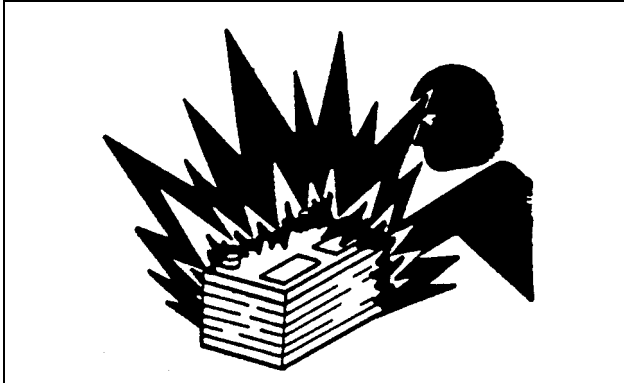

CAUTION: Avoid injury! Battery electrolyte contains sulfuric acid. It is poisonous and can cause serious burns:

The battery produces a flammable and explosive gas. The battery may explode:

- Do not smoke near battery.
- Wear eye protection and gloves.
- Do not allow direct metal contact across battery posts.
- Remove negative cable first when disconnecting.
- Install negative cable last when connecting.

Checking Battery

IMPORTANT: Avoid damage! Do not attempt to open, add fluid or service battery. Any attempt to do so will void warranty and lead to possible injury.

- Keep battery and terminals clean.
- Keep battery bolts tight.
- Keep small vent holes open.
- Charge, if necessary, at 6–10 amperes for 1 hour.

Removing and Installing the Battery

Removing:



CAUTION: Avoid injury! Always remove negative (–) battery cable first, and install it last, to prevent electrical short circuit to chassis.

1. Park machine safely. (See Parking Safely in the Safety section.)

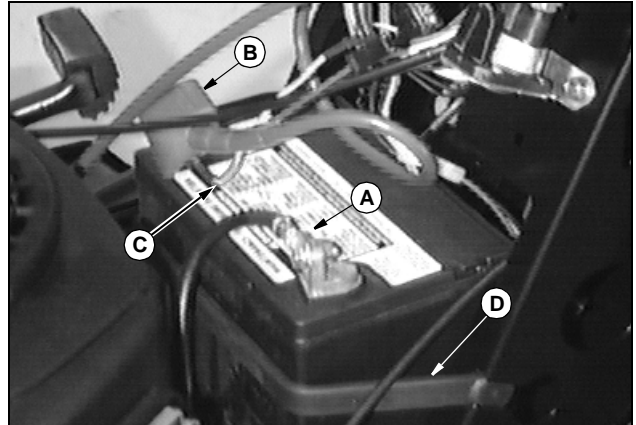

2. Disconnect negative (–) battery cable (A).
3. Push red cover (B) away from positive (+) battery cable and remove cable (C) from battery.
4. Remove rubber strap (D).
5. Remove battery.

Installing:

1. Place battery on battery tray.
2. Connect positive (+) cable to battery first, then negative (–) cable.
3. Apply dielectric grease to terminals to prevent corrosion.
4. Slide red cover over positive battery cable.
5. Install black rubber strap.

Cleaning Battery and Terminals

1. Disconnect and remove battery.
2. Wash battery with solution of four tablespoons of baking soda to one gallon of water. Be careful not to get the soda solution into the cells.
3. Rinse the battery with plain water and dry.
4. Clean terminals and battery cable ends with wire brush until bright.

SERVICE ELECTRICAL

5. Apply dielectric grease to terminals to prevent corrosion.
6. Install battery.

Using Booster Battery



CAUTION: Avoid injury! Do not attempt to jump start a frozen battery. Warm to 16 degrees C (60 degrees F).

Do not connect the negative (-) booster cable to the negative (-) terminal of the discharged battery. Connect at a good ground location away from the discharged battery.

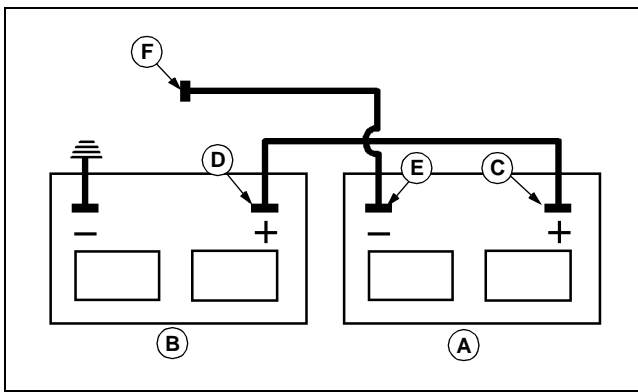

MX4663

A - Booster Battery
B - Disabled Vehicle Battery

1. Connect positive (+) booster cable to booster battery (A) positive (+) post (C).
2. Connect the other end of positive (+) booster cable to the disabled vehicle battery (B) positive (+) post (D).
3. Connect negative (-) booster cable to booster battery negative (-) post (E).
4. Connect the other end (F) of negative (-) booster cable to a metal part of the disabled machine frame away from battery.
5. Start the engine of the disabled machine and run machine for several minutes.
6. Carefully disconnect the booster cables in the exact reverse order: negative cable first and then the positive cable.

Replacing Fuse

1. Lift hood.

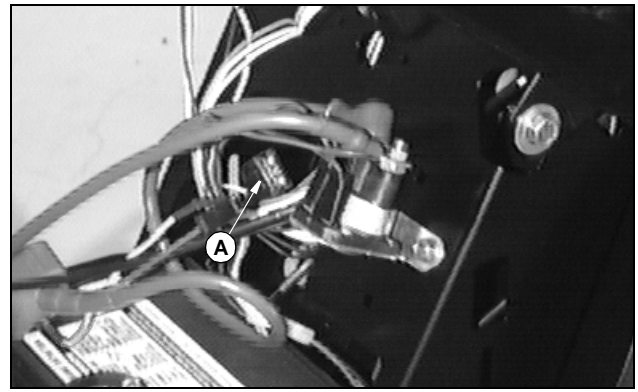

M88565

2. Pull defective fuse (A) out of socket.
3. Check metal clip in fuse window and discard fuse if clip is broken.
4. Push new fuse into socket.
5. Lower hood.

Replacing Headlight Bulb

1. Lift hood.

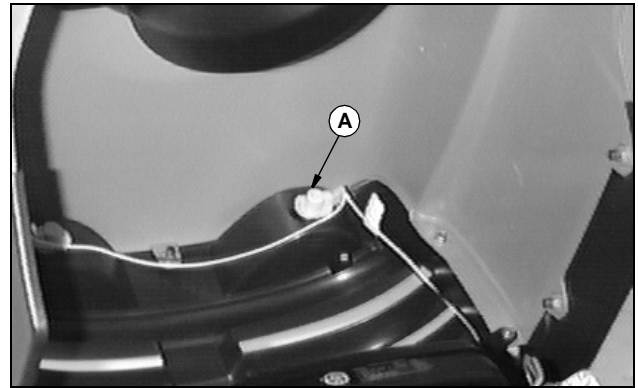

M88559

2. Push in and turn bulb socket (A) 1/4 turn counterclockwise to remove.
3. Replace defective bulb(s) with a new bulb.
4. Insert bulb socket into housing, push in and turn 1/4 turn clockwise to install.
5. Lower hood.

Replacing Battery Discharge and Oil Pressure Indicator Light Bulbs

NOTE: If more than one bulb is defective, replace only one bulb at a time. Make sure light socket is installed in correct holder.

1. Lift hood.

SERVICE ELECTRICAL

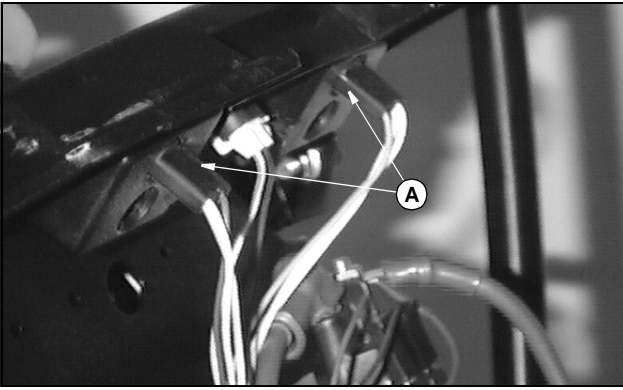

M88597

2. Turn indicator bulb socket (A) 1/8 turn counterclockwise to remove it.
3. Pull bulb from socket.
4. Push new bulb into socket and install socket into holder.
5. Lower hood.

SERVICE MISCELLANEOUS

Filling Fuel Tank

Use regular grade 87 octane unleaded fuel.

Add John Deere fuel stabilizer to fuel before using it in your machine to prevent engine damage due to stale fuel. Follow directions on stabilizer container.



CAUTION: Avoid injury! Fuel vapors are explosive and flammable:

- Shut engine off before filling fuel tank.
- Do not smoke while handling fuel.
- Keep fuel away from flames or sparks
- Fill fuel tank outdoors or in well ventilated area.
- Clean up spilled fuel immediately.
- Use clean approved non-metal container to prevent static electric discharge.
- Use clean approved plastic funnel without screen or filter to prevent static electric discharge.

IMPORTANT: Avoid damage! Dirt and water in fuel can cause engine damage:

- Clean dirt and debris from the fuel tank opening.
- Use clean, fresh, stabilized fuel.
- Fill the fuel tank at the end of each day's operation to keep condensation out of the fuel tank.
- Use a non-metallic funnel with a plastic mesh strainer when filling the fuel tank or container.

Cleaning and Repairing Plastic Surfaces

Your John Deere dealer has the professional materials needed to properly remove surface scratches from any plastic surfaces, do not attempt to paint over marks or scratches in plastic parts.

IMPORTANT: Avoid damage! Improper care of machine plastic surfaces can damage that surface:

- Do not wipe plastic surfaces when they are dry. Dry wiping will result in minor surface scratches.
- Use a soft, clean cloth (bath towel, diaper, automotive mitt).
- Do not use abrasive materials, such as polishing compounds, on plastic surfaces.
- Do not spray insect repellent near machine.

1. Rinse hood and entire machine with clean water to remove dirt and dust that may scratch the surface.
2. Wash surface with clean water and a mild liquid automotive washing soap.
3. Dry thoroughly to avoid water spots.
4. Wax the surface with a liquid automotive wax. Use products that specifically say "contains no abrasives."

IMPORTANT: Avoid damage! Do not use a power buffer to remove wax.

5. Buff applied wax by hand using a clean, soft cloth.

Cleaning and Repairing Metal Surfaces

Cleaning:

Follow automotive practices to care for your vehicle painted metal surfaces. Use a high-quality automotive wax regularly to maintain the factory look of your vehicle's painted surfaces.

Repairing Minor Scratches (surface scratch):

1. Clean area to be repaired thoroughly.

IMPORTANT: Avoid damage! Do not use rubbing compound on painted surfaces.

2. Use automotive polishing compound to remove surface scratches.
3. Apply wax to entire surface.

Repairing Deep Scratches (bare metal or primer showing):

1. Clean area to be repaired with rubbing alcohol or mineral spirits.
2. Use paint stick with factory-matched colors available from your John Deere dealer to fill scratches. Follow directions included on paint stick for use and for drying.
3. Smooth out surface using an automotive polishing compound. Do not use power buffer.
4. Apply wax to surface.

TROUBLESHOOTING

Using Troubleshooting Chart

When experiencing a problem that is not listed in this chart, see Authorized Service Center for service.

When all possible causes listed have been checked and there is still a problem, see Authorized Service Center.

Engine

If	Check
Engine Will Not Crank	Brake is not pushed down. Loose or corroded electrical connections. PTO knob is in ON position. Fuse is blown. Spark plug wire is loose or disconnected.
Engine Runs Unevenly	Cooling fins plugged. Loose electrical connections. Choke or throttle cable sticking or misadjusted choke left in ON position. Air cleaner dirty. Water in fuel or carburetor float bowl. Dirt in carburetor float bowl.
Engine Will Not Idle	Spark plug not gapped correctly. Faulty spark plug. Choke on or partially on (warm engine).
Engine Is Hard To Start	Fuel filter is gummed or plugged. Spark plug is fouled. Faulty spark plug or wire. Spark plug is not gapped correctly. Loose or corroded electrical connections. Stale fuel. Choke is adjusted or used incorrectly.
Engine Misses Under Load	Faulty spark plug. Stale fuel. Dirt or water in carburetor float bowl.
Engine Vapor Locks	Fuel tank vent plugged. Dirt in fuel filter. Debris plugging fuel pick-up tube inside fuel tank.

TROUBLESHOOTING

If	Check
Engine Overheats	Engine air intake screen plugged. Cooling fins plugged. Engine oil low. Engine operated too long at slow idle speed.
Engine Loses Power	Engine overheating. Too much oil in engine. Dirty air cleaner. Faulty spark plug.
Engine Knocks	Low engine speed. Stale or low octane fuel. Engine overloaded. Oil level low.
Engine Backfires	Faulty spark plug. Operator raising off seat. Shut down procedure for engine not correct.
Engine Stops When REVERSE foot pedal is depressed and Attachment Is Engaged	Normal condition. (See Using Reverse Implement Option in OPERATING section.)

Machine

If	Check
Machine Vibrates Too Much	Attachment drive belts worn or damaged. Dirt on drive sheaves.
Machine Will Not Move With Engine Running	Transmission hydraulic oil level low. Parking brake locked.
Machine Moves With Engine Running And Hydrostatic Control In Neutral	Linkage out of adjustment.

Electrical

If	Check
Starter Does Not Work Or Will Not Turn Engine	Brake pedal not down. PTO knob in ON position. Battery terminals corroded. Battery dead or low charge.

TROUBLESHOOTING

If	Check
Battery Will Not Charge	Battery cables and terminals dirty. Low engine speed or excessive idling. Dead cell in battery.

Mower

If	Check
Discharge Chute Plugging	Belt installed incorrectly. Grass too wet. Grass too long. Restricted air flow. Check mower front-to-rear level. Engine rpm too low. Travel speed too fast.
Patches Of Grass Uncut	Travel speed too fast. Engine rpm too low.
Belt Slipping	Debris in sheaves. Worn belt.
Too Much Vibration	Debris on mower or in sheaves. Damaged drive belt. Damaged sheaves or sheaves out of alignment. Blades out of balance.
Blades Scalping Grass	Cutting too low. Turning speed too fast. Ridges in terrain. Rough or uneven terrain. Low tire pressure. Mower gauge wheels not adjusted correctly. Bent blade(s).
Uneven Cut	Mower not level. Travel speed too fast. Blades dull. Mower gauge wheels not adjusted correctly. Tire pressure.
Requires High Effort To Lift And Latch Lift Handle	Front draft arm on mower is adjusted too short, causing lift system to bind up.

TROUBLESHOOTING

If	Check
Mower Loads Down Machine	Engine rpm too low. Travel speed too fast. Debris wrapped around mower spindles. Bagging blades on mower.
Grass Tips Are Jagged And Turn Grayish Brown After Mowing	Dull mower blades. Bent blades. Front-to-rear blade adjustment not set properly.
Mower (or other attachment) Stops When REVERSE foot pedal is depressed and Attachment Is Engaged	Normal condition. (See Using Reverse Implement Option in OPERATING section.)

STORING MACHINE

Storing Safety



CAUTION: Avoid injury! Fuel vapors are explosive and flammable. Engine exhaust fumes contain carbon monoxide and can cause serious illness or death:

- Run the engine only long enough to move the machine to or from storage.
- Do not store vehicle with fuel in the tank inside a building where fumes may reach an open flame or spark.
- Allow the engine to cool before storing the machine in any enclosure.

Preparing Machine for Storage

1. Repair any worn or damaged parts. Replace parts if necessary. Tighten loose hardware.
2. Clean under mower.
3. Paint scratched or chipped metal surfaces to prevent rust.
4. Wash machine and apply wax to metal and plastic surfaces. (See Service-Miscellaneous section for care of plastic and metal surfaces.)
5. Run machine for five minutes to dry belts and pulleys.
6. Apply light coat of engine oil to pivot and wear points to prevent rust.
7. Lubricate grease points.
8. Make sure tires are properly inflated.

Preparing Engine For Storage

NOTE: Properly preparing machine engine for storage will make it easier to start at beginning of following season. Engine storage procedure should be used if machine is not used for longer than 60 days.

There are two satisfactory methods of preparing engine for storage: running engine completely dry of fuel, or filling fuel tank with a mixture of fresh fuel and fuel stabilizer.

Running engine dry of fuel:

NOTE: Try to anticipate last time machine will be used for season so very little fuel is left in fuel tank.

1. Park machine in a well-ventilated area.
2. Engage park brake and disengage PTO.
3. Turn on engine and allow to run until it runs out of fuel.

4. Turn key to off position.
5. Continue with Preparing Engine.

Add fuel and stabilizer mixture to tank:

1. Park machine in a well-ventilated area.

IMPORTANT: Avoid damage! Be sure fuel is fresh when adding fuel stabilizer. Fuel stabilizers are ineffective when added to fuels that are more than 30 days old.

2. Mix fresh fuel and fuel stabilizer in separate container. Follow stabilizer instructions for mixing.

NOTE: Filling fuel tank reduces amount of air in fuel tank and helps reduce deterioration of fuel.

3. Fill fuel tank with stabilized fuel.
4. Run engine for a few minutes to allow fuel mixture to circulate through carburetor.
5. Continue with Preparing Engine.

Preparing Engine:

1. Change engine oil and filter while engine is warm.
2. Service air filter if necessary.
3. Clean debris from engine air intake screen.
4. Remove spark plugs. Put 30 mL (1 oz.) of clean engine oil in cylinders.
5. Install spark plugs, but do not connect spark plug wires.
6. Crank engine for approximately five seconds to allow oil to be distributed.
7. Clean engine and engine compartment.
8. Remove battery.
9. Clean battery and battery posts.

NOTE: Stored battery should be charged every 90 days.

10. Charge battery. (See Charging Battery in Service - Electrical section.)
11. Store battery in a cool, dry place where it will not freeze.
12. Store machine in a dry, protected place. If machine is stored outside, put a waterproof cover over it.

Removing Machine From Storage

1. Check tire pressure. (See Checking Tire Pressure in Service - Miscellaneous section.)
2. Fill fuel tank. Check engine oil level.
3. Take machine off of blocks or support stands.

STORING MACHINE

4. Charge battery if necessary. Install battery. (See Removing and Installing Battery in Service-Electrical section.)
5. Check spark plug gap. Install and tighten spark plug to 20 N•m (15 lb-ft).
6. Lubricate all grease points.
7. Run engine 5 minutes without mower or any attachments running to allow oil to be distributed throughout engine.
8. Be sure all shields and guards are in place.

SPECIFICATIONS

Engine

Engine Manufacturer	Kohler
Engine Model Number	CV25S-69542
Horsepower	18.6 kW (25 hp)
Displacement	725 cc (44.0 cu in)
Spark Plug-Gap	0.76 mm (0.030 in)
Spark Plug-Torque	24.4-29.8 N•m (18-22 lb-ft)
Cylinders	Two
Stroke/Cycle	Four
Lubrication	Full-Pressure
Oil Filter	Standard Single Element
Air Cleaner	Dual Stage
Fuel Filter	Replaceable

Capacities

Crankcase with filter	2.1 L (2.2 qt)
Fuel Tank	11 L (3.0 gal)

Transaxle

Model	Tuff Torq, Model K66C
Drive Train	Transaxle with foot-controlled variable speed drive
Travel Speed-Forward	0-8.8 km/h (0-5.5 mph)
Travel Speed-Reverse	0-3.5 km/h (0-2.5 mph)

Dimensions

Overall Height	115.7 cm (45.6 in.)
Overall Length	183.6 cm (72.3 in.)
Machine Weight	275 kg (606 lb.)

Tire Sizes

Front	16 X 7.50
Rear	24 X 12.00

Mower

Blades-Rotary	3
---------------------	---

SPECIFICATIONS

Blade Bolt Torque	84 N•m (62 lb-ft)
Cutting Height-Approx.	25–102 mm (1–4 in)
Blade Length	474 mm (18.7 in)
Cutting Width	1372mm (54 in)

Recommended Lubricants

Engine Oil	John Deere PLUS-4
Transmission Oil.....	SAE 10W30
Grease	John Deere MOLY HIGH Temperature EP

(Specifications and design subject to change without notice.)

WARRANTY

Product Warranty

The warranties described below are provided by John Deere Company ("John Deere") to the original purchasers of new Scotts Products. Product warranty is provided as part of John Deere's support program for customers who operate and maintain their equipment as described in this manual. The following warranty information is in addition to the product warranty information you received from your dealer at the time of sale.

All parts of any new Scotts product, except tires and batteries, are warranted for the number of months / days specified below:

SCOTTS PRODUCTS	WARRANTY TERM
IN RESIDENTIAL (Private Homeowner) APPLICATION	24 Months
IN ANY OTHER APPLICATION	90 Days

Tire Warranty

John Deere warranty applies for tires available through the John Deere parts system. For tires not available through the John Deere parts system, the tire manufacturer's warranty applicable to your machine may not apply outside the U.S. (See your John Deere dealer for specific information.)

John Deere, Federal and California Emission Control System Warranty (Small Off-Road Gas Engines)

Your Warranty Rights and Obligations

The United States Environmental Protection Agency (EPA), the California Air Resources Board (CARB) and John Deere are pleased to explain the emission control system warranty on your 1995 or later small off-road equipment engine. In California, 1995 and later small off-road equipment engines must be designed, built and equipped to meet the State's stringent anti-smog standards. In other states, 1997 and later model year equipment engines must be designed, built and equipped to meet the U.S. EPA regulations for small non-road, spark ignition engines. John Deere must warrant the emission control system on your small off-road equipment engine for the periods of time listed below provided there has been no abuse, neglect or improper maintenance of your small off-road equipment engine.

Your emission control system may include parts such as the carburetor, fuel-injection system and ignition system. Also included may be connectors and other emission related assemblies.

Where a warrantable condition exists, John Deere will repair your small off-road equipment engine at no cost to you including diagnosis, parts and labor.

John Deere Emission Control System Warranty Coverage

In California, 1995 and later small off-road equipment engines are warranted relative to emission control parts for two years. In other states, 1997 and later model year equipment engines are warranted relative to emission control parts for two years. If any emission related part on your engine is defective, the part will be repaired or replaced by John Deere.

Owner's Warranty Responsibilities

As the small off-road equipment engine owner, you are responsible for the performance of the required maintenance listed in your owner's manual. John Deere recommends that you retain all receipts covering

maintenance on your small off-road equipment engine, but John Deere cannot deny warranty solely for lack of receipts or for your failure to ensure the performance of all scheduled maintenance.

As the small off-road equipment engine owner, you should however be aware that John Deere may deny you warranty coverage if your small off-road equipment engine or a part has failed due to abuse, neglect, improper maintenance or unapproved modifications.

You are responsible for presenting your small off-road equipment engine to an authorized John Deere Commercial and Consumer Equipment Retailer as soon as a problem exists. The warranty repairs should be completed in a reasonable amount of time, not to exceed 30 days.

If you have any questions regarding your warranty rights and responsibilities, you should contact your John Deere Commercial and Consumer Equipment Retailer, or the John Deere Customer Communications Center at 1-800-537-8233.

Length Of Warranty Coverage

John Deere warrants to the initial owner and each subsequent purchaser that the small off-road equipment engine is:

- Designed, built and equipped so as to conform with all applicable regulations adopted by the California Air Resources Board (CARB) for 1995 and later equipment engines, and all applicable regulations of the United States Environmental Protection Agency (EPA) for 1997 and later equipment engines; and
- Free from defects in materials and workmanship which can cause the failure of an emission warranted part for a period of two years after the engine is delivered to the initial retail purchaser. John Deere is liable for damages to other engine components caused by the failure of a warranted part during the warranty period. If any emission related part on your engine is defective, the part will be repaired or replaced by John Deere.

Warranted Parts

Coverage under this warranty extends only to the parts listed below (the emission control system parts) to the extent these parts were present on the engine purchased.

Fuel Metering System:

- Carburetor and internal parts (or fuel injection system).
- Air/fuel ratio feedback and control system.
- Cold start enrichment system.

Air Induction System:

- Air Cleaner
- Intake manifold.

Ignition System:

- Spark plugs.
- Magneto or electronic ignition system.
- Spark advance/retard system.

Catalyst System:

- Exhaust manifold.

Miscellaneous Items Used in Above Systems

- Vacuum and temperature switches.
- Electronic controls.
- Hoses, belts, connectors and assemblies.

Since emission related parts may vary slightly from model to model, certain models may not contain all of these parts and certain models may contain functionally equivalent parts.

WARRANTY

Warranty Service And Charges

Warranty service shall be provided during customary business hours at any authorized John Deere Commercial and Consumer Equipment Retailer located within the United States of America. Repair or replacement of any warranted part will be performed at no charge to the owner, including diagnostic labor which leads to the determination that a warranted part is defective, if the diagnostic work is performed at an authorized John Deere Commercial and Consumer Equipment Retailer. Any parts replaced under this warranty shall become the property of John Deere.

Maintenance Warranty Coverage

a) Any warranted part that is not scheduled for replacement as required maintenance must be warranted as to defects for the warranty period. Any such part repaired or replaced under the warranty must be warranted for the remaining warranty period.

b) Any warranted part that is scheduled only for regular inspection to the effect of "repair or replace as necessary" must be warranted as to defects for the warranty period. Any such part repaired or replaced under the warranty must be warranted for the remaining warranty period.

c) Any warranted part which is scheduled for replacement as required maintenance must be warranted as to defects only for the period of time up to the first scheduled replacement for that part. Any such part repaired or replaced under the warranty must be warranted for the remainder of the period prior to the first scheduled replacement point for that part.

d) Normal maintenance, replacement or repair of emission control devices and systems, which are being done at the customers expense, may be performed by any repair establishment or individual; however, warranty repairs must be performed by an authorized John Deere Commercial and Consumer Equipment Retailer.

e) Any replacement part that is equivalent in performance and durability may be used in the performance of any non-warranty maintenance or repairs, and shall not reduce the warranty obligations of John Deere.

Consequential Warranty Coverage

Warranty coverage shall extend to the failure of any engine components caused by the failure of any warranted part still under warranty.

Limitations

This Emission Control System Warranty shall NOT cover any of the following:

a) Repair or replacement required as a result of (i) misuse or neglect, (ii) improper maintenance or unapproved modifications, (iii) repairs improperly performed or replacements improperly installed, (iv) use of replacement parts or accessories not conforming to John Deere specifications which adversely affect performance and/or durability, (v) alterations or modifications not recommended or approved in writing by John Deere.

b) Replacement parts, other services and adjustments necessary for normal maintenance.

c) Transportation to and from the John Deere Commercial and Consumer Equipment Retailer, or service calls made by the Retailer.

Limited Liability

a) The liability of John Deere under this Emission Control System Warranty is limited solely to the remedying of defects in materials or workmanship. This warranty does not cover inconvenience or loss of use of the small off-road equipment engine or transportation of the engine to or from the John Deere Commercial And Consumer Equipment Retailer. JOHN DEERE SHALL NOT BE LIABLE FOR ANY OTHER EXPENSE, LOSS, OR DAMAGE, WHETHER DIRECT, INCIDENTAL, CONSEQUENTIAL (EXCEPT AS LISTED ABOVE UNDER "COVERAGE") OR EXEMPLARY ARISING IN CONNECTION WITH THE

SALE OR USE OF OR INABILITY TO USE THE SMALL OFF-ROAD EQUIPMENT ENGINE FOR ANY OTHER PURPOSE.

b) NO EXPRESS EMISSION CONTROL SYSTEM WARRANTY IS GIVEN BY JOHN DEERE WITH RESPECT TO THE ENGINE EXCEPT AS SPECIFICALLY SET FORTH IN THIS DOCUMENT. ANY EMISSION CONTROL SYSTEM WARRANTY IMPLIED BY LAW, INCLUDING ANY WARRANTY OF MERCHANTABILITY OR FITNESS FOR A PARTICULAR PURPOSE, IS EXPRESSLY LIMITED TO THE EMISSION CONTROL SYSTEM WARRANTY TERMS SET FORTH IN THIS DOCUMENT.

c) No dealer is authorized to modify this Federal, California and John Deere Emission Control System Warranty.

Limited Battery Warranty

NOTE: Applicable in North America only.

TO SECURE WARRANTY SERVICE

The purchaser must request warranty service from a John Deere dealer authorized to sell John Deere batteries, and present the battery to the dealer with the top cover plate codes intact.

FREE REPLACEMENT

Any new battery which becomes unserviceable (not merely discharged) due to defects in material or workmanship within 90 days of purchase will be replaced free of charge. Installation costs will be covered by warranty if (1) the unserviceable battery was installed by a John Deere factory or dealer, (2) failure occurs within 90 days of purchase, and (3) the replacement battery is installed by a John Deere dealer.

PRO RATA ADJUSTMENT

Any new battery which becomes unserviceable (not merely discharged) due to defects in material or workmanship more than 90 days after purchase, but before the expiration of the applicable adjustment period, will be replaced upon payment of the battery's current list price less a pro rata credit for unused months of service. The applicable adjustment period is determined from the Warranty Code printed at the top of the battery and chart below. Installation costs are not covered by warranty after 90 days from the date of purchase.

THIS WARRANTY DOES NOT COVER

- A. Breakage of the container, cover, or terminals.
- B. Depreciation or damage caused by lack of reasonable and necessary maintenance or by improper maintenance.
- C. Transportation, mailing, or service call charges for warranty service.

LIMITATION OF IMPLIED WARRANTIES AND PURCHASER'S REMEDIES

To the extent permitted by law, neither John Deere nor any company affiliated with it makes any warranties, representations, or promises as to the quality, performance or freedom from defect of the products covered by this warranty. IMPLIED WARRANTIES OF MERCHANTABILITY AND FITNESS FOR A PARTICULAR PURPOSE, TO THE EXTENT APPLICABLE, SHALL BE LIMITED IN DURATION TO THE APPLICABLE ADJUSTMENT PERIOD SET FORTH HERE. THE PURCHASER'S ONLY REMEDIES IN CONNECTION WITH THE BREACH OR PERFORMANCE OF ANY WARRANTY ON JOHN DEERE BATTERIES ARE THOSE SET FORTH HERE. IN NO EVENT WILL THE DEALER, JOHN DEERE OR ANY COMPANY AFFILIATED WITH JOHN DEERE BE LIABLE FOR INCIDENTAL OR CONSEQUENTIAL DAMAGES. (Note: Some states do not allow limitations on how long an implied warranty lasts or the exclusion or limitation of incidental or consequential damages. So these limitations and exclusions may not apply to you.) This warranty gives

WARRANTY

you specific legal rights, and you may also have some rights which vary from state to state.

NO DEALER WARRANTY

The selling dealer makes no warranty of it's own and the dealer has no authority to make any representation or promise on behalf of John Deere, or to modify the terms or limitations of this warranty in any way.

PRO RATA MONTHS OF ADJUSTMENT

NOTE: If your battery is not labeled with a warranty code, it is a warranty code B.

Warranty Code	Warranty Period
A	40 Months
B	36 Months
C	24 Months

INDEX

A

Air Cleaner Elements, Checking and Cleaning	26
Air Intake Screen and Engine Fins, Cleaning	26
Assembly Parts	8
Automatic Transmission, Using and Stopping	17
Axle Pivot, Lubricating	23

B

Battery Discharge Light	16
Battery and Terminals, Cleaning	34
Battery, Checking the	34
Battery, Connect and Check	8
Battery, Removing and Installing	34
Battery, Using Booster	35
Belt, Adjusting Mower Drive Tension	32
Belt, Replacing Mower Drive	31
Blades, Balancing	33
Blades, Servicing Mower	32
Blades, Sharpening and Balancing	33
Brake, Using the Park	15
Bulbs, Replacing	35
Bulbs, Replacing Headlight	35

C

Carburetor, Adjusting	24
Certification Label	3
Chains, Using and Installing Tire	20
Clutch, Break-In Electric PTO	9
Controls	10
Cutting Height, Adjusting	11

E

Engine Fins, Cleaning Air Intake Screen and	26
Engine Oil	24
Engine Oil, Check	8
Engine Warranty Maintenance Statement	24
Engine for Storage, Preparing	43
Engine, Starting	16
Engine, Stopping	17
Engine, Warming and Idling	17

F

Filter, Replacing Fuel	28
Fuel Filter, Replacing	28
Fuel Safety	7
Fuel Tank, Filling	37
Fuse, Replacing	35

G

Grease	23
--------------	----

H

Headlights, Using	15
Hour Meter, Checking Indicator Lights and	16

I

Implement Option, Using Reverse	19
Indicator Lights and Hour Meter, Checking	16

L

Label, Certification	3
Labels, Safety	1
Leveling Mower (Front-to-Rear)	12
Leveling Mower (Side-to-Side)	12
Lift Lever to Raise and Lower Mower, Using	18
Lights and Hour Meter	16
Lubricants Recommended	46
Lubricating Mower Spindles	23
Lubricating Wheel Spindles and Axle Pivot	23

M

Metal Surfaces, Repairing and Cleaning	37
Mower Level (Front-to-Rear), Adjusting	12
Mower Level (Side-to-Side), Adjusting	12
Mower Spindles, Lubricating	23
Mower Wheels, Adjusting	11
Mower, Engaging and Disengaging	18
Mower, Installing	30
Mower, Raising and Lowering	18
Mower, Removing	30

O

Oil Filter, Changing Engine	25
Oil Pressure Light	16
Oil, Changing Engine	25
Oil, Check Engine	8
Oil, Engine	24
Operating Checklist	10

P

PTO Clutch, Break-In Electric	9
Part Numbers	21
Parts Catalog	21
Parts, Identify	8
Plastic Surface Cleaning and Repairing Surfaces	37
Pushing Machine	19

R

Reverse Implement Option, Using	19
---------------------------------------	----

S

Safety Labels	1
Safety Messages	3
Safety System, Check Machine	9
Safety Systems, Testing	13
Safety, Tire	6
Screen and Engine Fins, Cleaning Air Intake	26
Seat, Adjusting	11
Spark Plugs, Checking	27
Steering Wheel, Install	8
Storage, Preparing Engine for	43

INDEX

Storage, Preparing Machine for	43
Storage, Removing Machine from	43
Storing Safety	43

T

Technical Manual	21
Testing Safety Systems	13
Tire Chains	20
Tire Pressure, Checking	9
Tire Specifications	45
Transmission Fluid Level, Checking	29
Transmission Fluid, Adding	29
Transporting Machine on Trailer	20
Troubleshooting Chart, Using	38

W

Warranty Maintenance Statement, Engine	24
Warranty, Product	47
Weights, Using Front or Rear	20
Weights, Using Rear Wheel	20
Wheel Spindles, Wheel Bearings and Front Axle Pivot, Lubricating Front	23
Wheels, Adjusting Mower	11

SCOTTS QUALITY STATEMENT

Please do not return this product to the store where you purchased it.

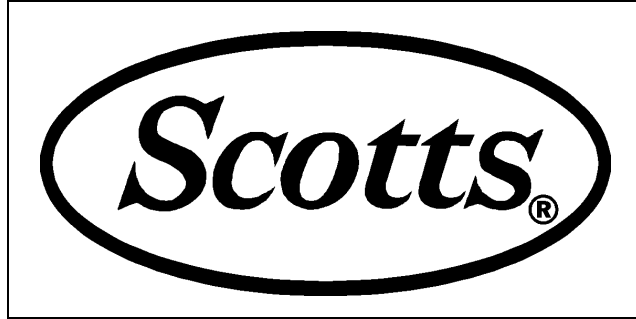

Your Scotts product, designed and built by John Deere, is more than just a purchase, it's an investment in quality. That quality goes beyond our equipment to your dealer's parts and service support.

That's why John Deere has initiated a process to handle your questions or problems, should they arise. If you have questions or problems with your new product, please follow the steps below. To locate your nearest authorized Scotts servicing dealer, please call toll free 1-800-537-8233.

Step 1

Refer to your operator's manual

- A. It has many illustrations and detailed information on the safe and proper operation of your equipment.
- B. It gives troubleshooting procedures, and specification information.
- C. It gives ordering information for parts catalogs, service and technical manuals.
- D. If your questions are not answered in the operator's manual, then go to Step 2.

Step 2

Contact your dealer (Call 1-800-537-8233 to locate your nearest John Deere dealer)

- A. Your John Deere dealer has the responsibility, authority, and ability to answer questions, resolve problems, and fulfill your parts and service needs.
- B. First, discuss your questions or problems with your dealer's trained parts and service staff.
- C. If the parts and service people are unable to resolve your problem, see the dealership manager or owner.
- D. If your questions or problems are not resolved by the dealer, then go to Step 3.

Step 3

Call the John Deere Customer Communications Center

- A. Your John Deere dealer is the most efficient source in addressing any concern, but if you are not able to resolve your problem after checking your operator's manual and contacting your dealer, call the Customer Communications Center.
- B. For prompt, effective service, please have the following ready before you call:
 - The name of the dealer with whom you've been working.
 - Your equipment model number.
 - Number of hours on machine (if applicable).
 - Your 13-digit serial number which you recorded on the inside front cover of this manual.
 - If the problem is with an attachment, your attachment identification number.
- C. Then call 1-800-537-8233 and our advisor will work with your dealer to investigate your concern.

SERVICE RECORD

Record Service Dates

Oil Change	Oil Filter Change	Lubricate Machine	Air Cleaner Element Check/Clean	Fuel Filter Change